

Curriculum Vitae

- 1949 Born in Yamanashi Prefecture
- 1949 Osaka
- 1954 Tokyo (5 year old)
- 1958 Osaka (9 year old)
- 1968-1978 Osaka University
- 1978 Tohoku University
- 1984-1985 Arizona State University
- 1990 Tonomura Wave Front Project (JRDC ERATO)
- 1995 Nagoya University, CIRSE (理工科学総合研究センター)
- 2002 Nagoya University, Department of electrical Engineering and Communication Science
- 2007 Nagoya University, EcoTopia Science Institute

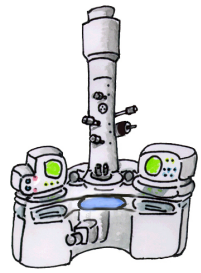

With Prof. Hatsujiro Hashimoto

at IMC 2006 (85 year old)



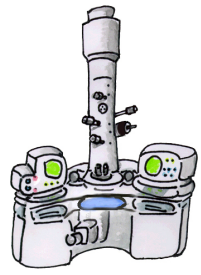

Prof. Keiji Yada at 77 year old party



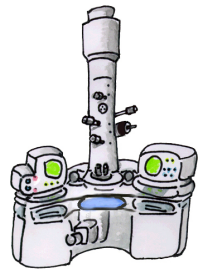

Young Prof. John Cowley



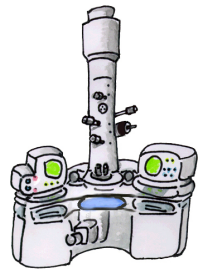

With Prof. John M. Cowley

at 80 year old party



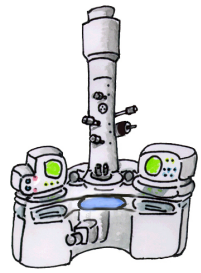

Dr. Akira Tanomura



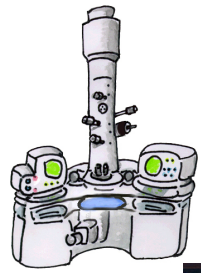

With Akira Tonomura, Sumio Iijima &



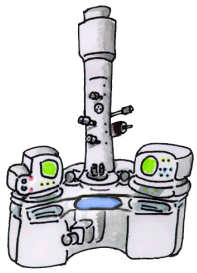

With Dr. Akira Tonomura & . . .

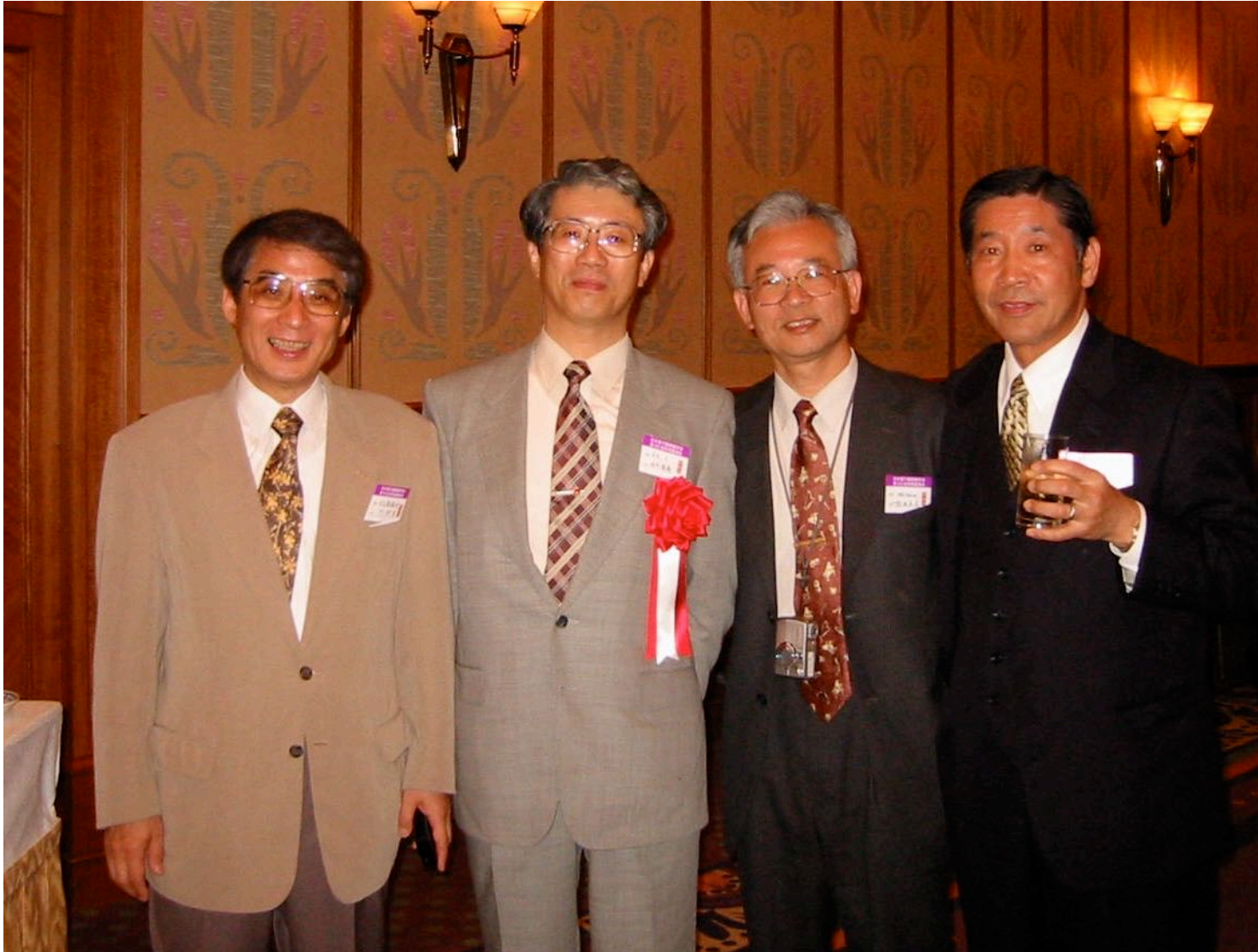

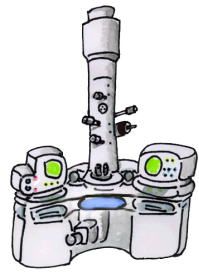

History of Studies

- 1971-1972 Osaka Univ. BS: Measurements of work functions by photoemission
- 1972-1978 Osaka Univ. MS & PhD: Optical image processing of high resolution electron microscopic images
- 1978-1984 Tohoku Univ. Assistant Prof. : High resolution observation of asbestos
- 1984-1985 ASU: High resolution observation of the surface profile of MgO
- 1985-1990 Tohoku Univ. Assistant Prof. & Associate Prof. :
- X-ray diffraction effects on quantitative analysis by EDX
 - Scanning image detection system for TEM
 - **Simulation of electron holography** ▪ ▪ ▪ ▪ **Start of surfing**
- 1990-1995 Tonomura Project , Group Leader:
- High resolution electron holography and observation of magnetics

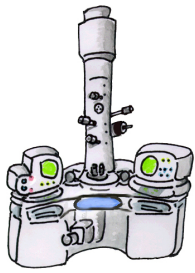

History of Studies

1995- Nagoya University:

- Precise electron holography (phase shifting EH)
- Differential electron holography 科研費基盤(B)
- Observations of magnetics by EH and Lorentz microscopy 経済産業省「次世代自動車向け高効率モーター用磁性材料技術開発」
Magnetic nano particles, Magnetic multi layers 科研費基盤(B)、
特定A (公募・計画)
- Field emission gun of carbon nano tubes 科研費基盤(B)
- Stereoscopic TEM with TV rate 科研費基盤(A)
- *In situ* observation of SOFC 科研費特定領域(計画)、基盤(A)、文科省「ナノテクノロジーを活用した環境技術開発プログラム」ナノ材料科学環境拠点(GREEN)
- Phase plate using A-B effect 科研費基盤(A)

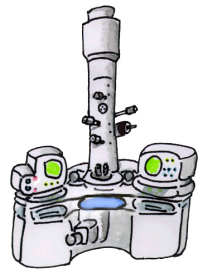

Contents

1. Introduction
2. Interference of waves
3. Electron holography
 - High resolution imaging
 - Observation of Magnetic field
5. Stereoscopic TEM
6. Phase plate using A-B effect

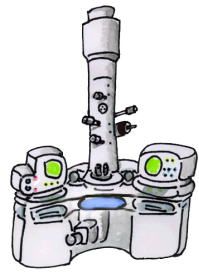

Contents

1. Introduction

2. Interference of waves

3. Electron holography

- High resolution imaging
- Observation of Magnetic field

5. Stereoscopic TEM

6. Phase plate using A-B effect

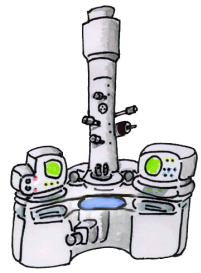

What's This ?



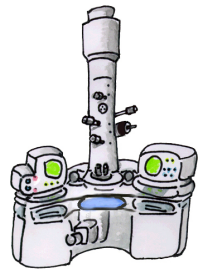

Equipotential Lines



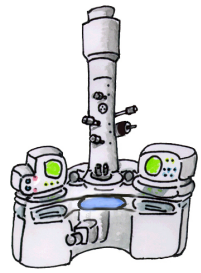

What's This ?

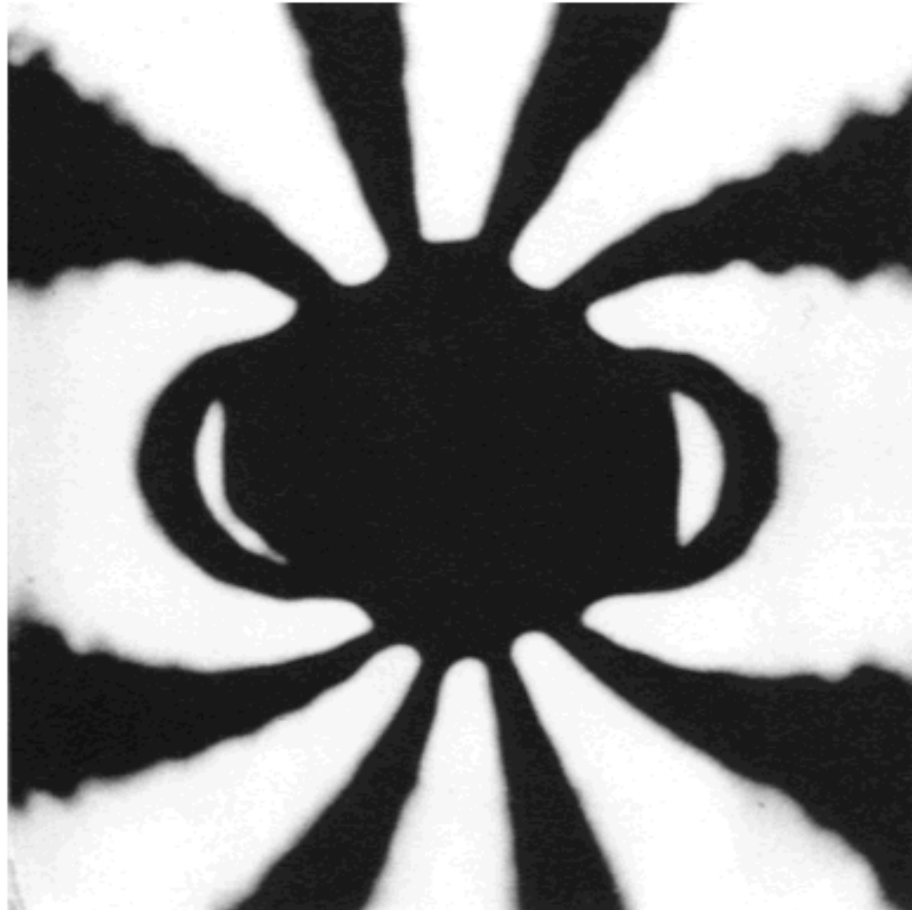

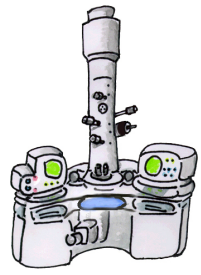

Magnetic Line of Force

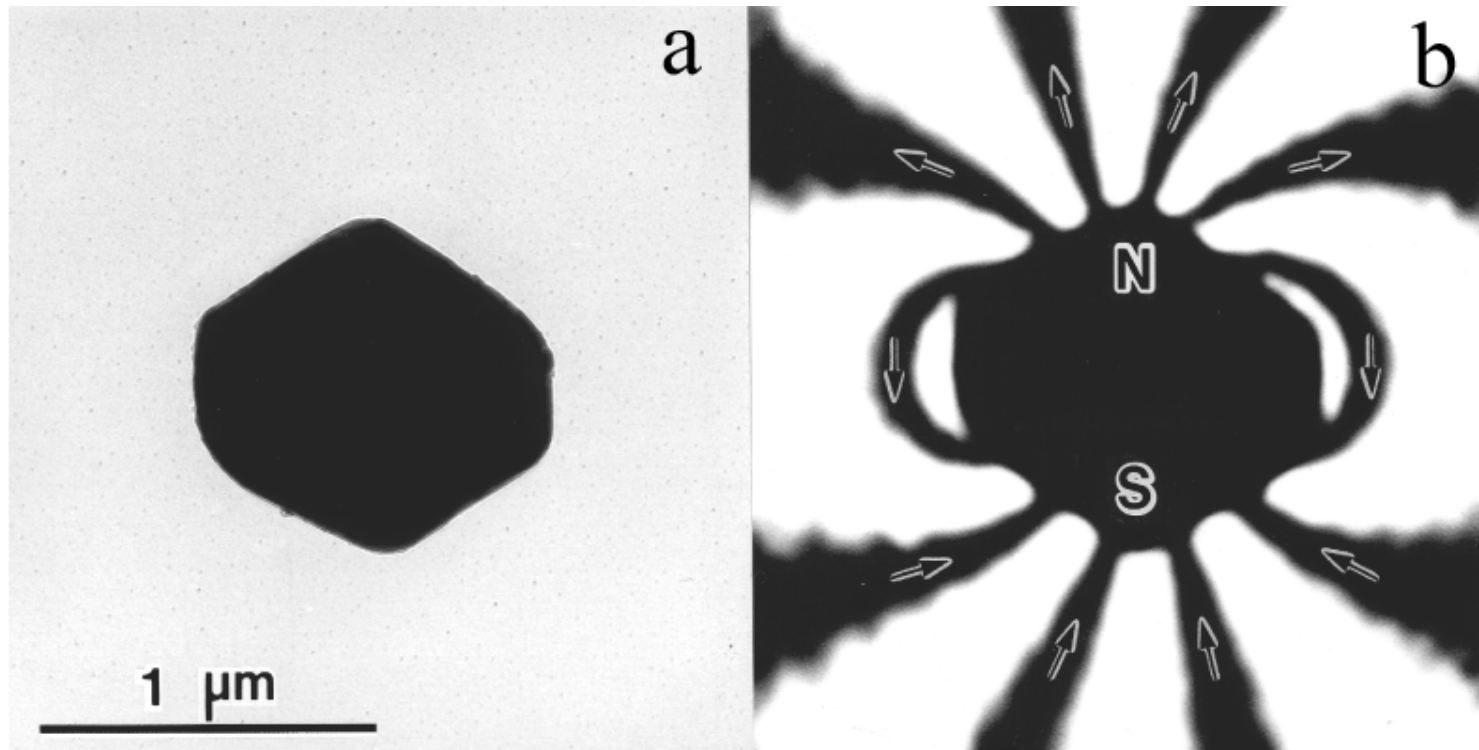

Magnetic Structure of Ferromagnetic

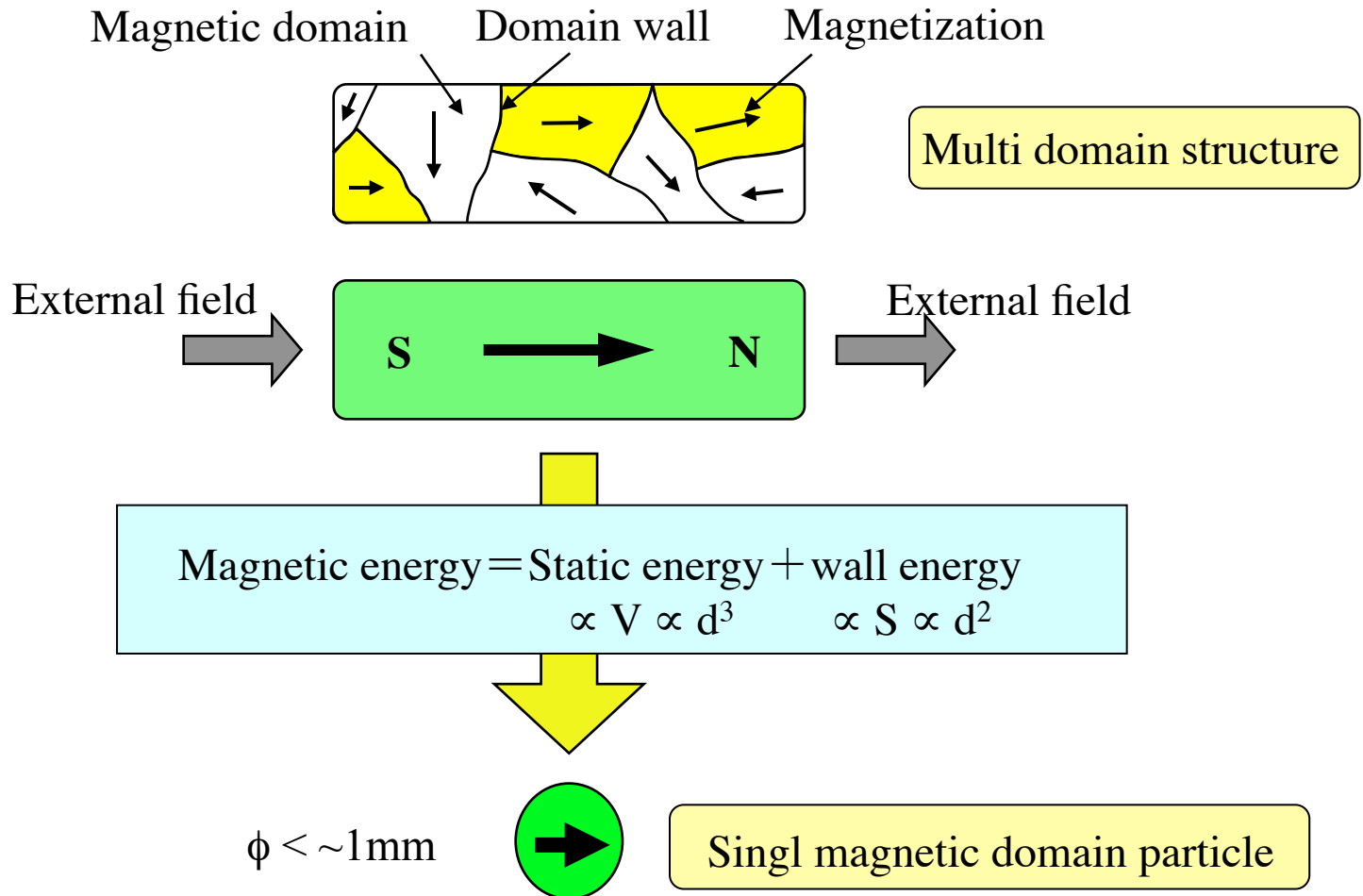
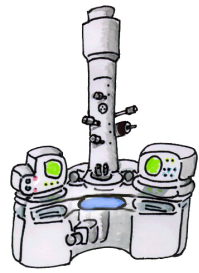

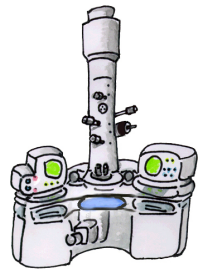

Single Magnetic Domain Particle of Ba-Ferrite

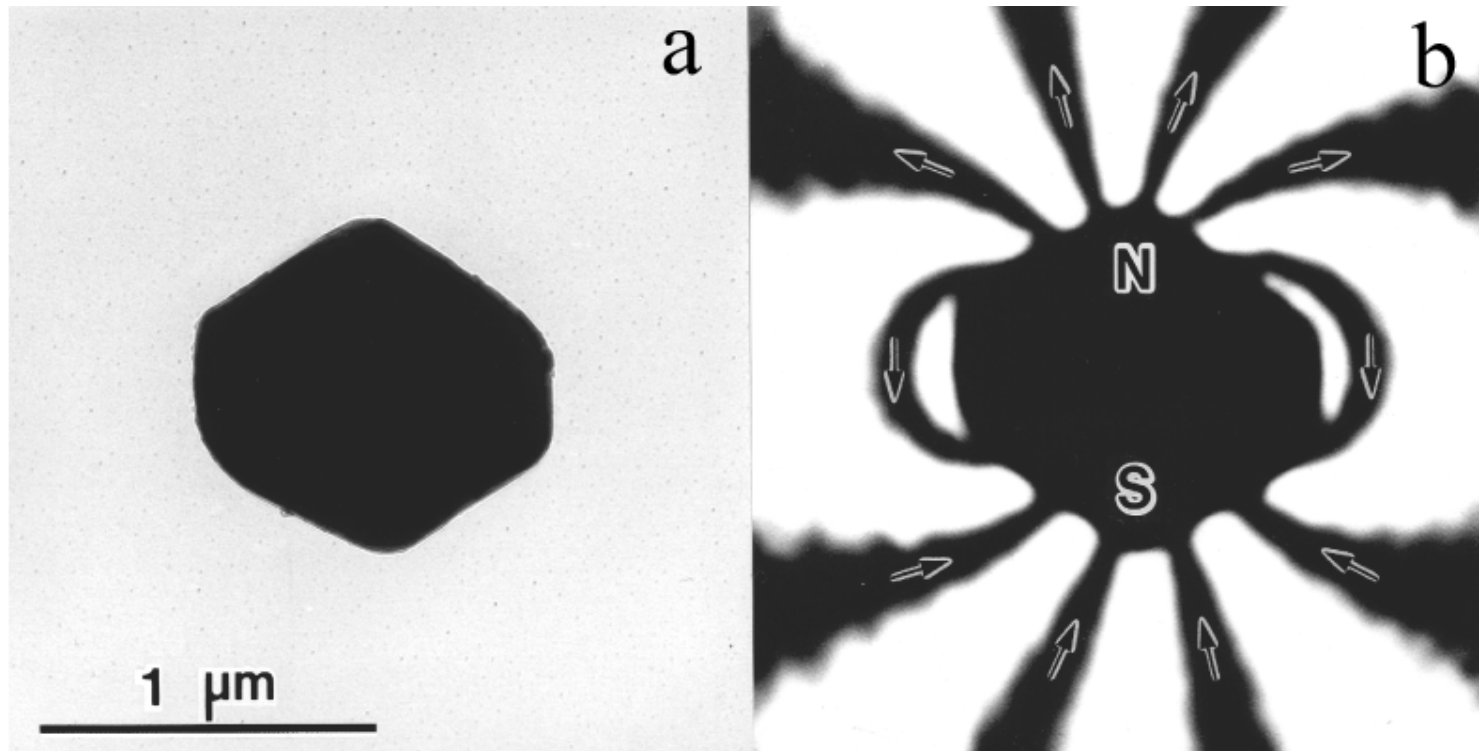

Development of Electron Microscope

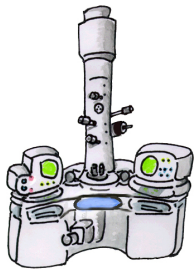

1858	J. Plücker	陰極線の発見
1869	J. W. Hittorf	陰極線の電磁偏向
1874	E. Abbe	顕微鏡の分解能限界
1897	J. J. Thomson	電子の存在を確認
1899	E. Wiechert	軸方向磁界によるスポット径縮小
1924	L. de Broglie	電子の波動性 (物質波)
1927	C.J.Davison & L.H.Germer	Ni表面での電子線回折実験
	H. Busch	回転対称磁界のレンズ作用
1931.5.5 6.4	R. Rüdénberg	電子顕微鏡の特許申請
	M. Knoll & E. Ruska	電子顕微鏡 (磁界型) で最初の像(x17)を発表
1933	B. von Borries & E. Ruska	2段磁界型電顕で光顕を超える(75kV, x12,000, 50nm)
1934	L. Marton	Os染色による生物試料の撮影(x3,900)
	E.Sugata	大阪大学
1935	M. Knoll	走査電子顕微鏡(SEM)
1936	Metropolitan-Vickers社	商用第1号機 EM-1 (20kV, >1 μ m)
	J.Okubo & T.Hibi	東北大学

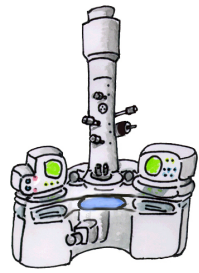

1939	H. Mahl & H. Boersch	静電型電子顕微鏡 AGE社 (8nm)
	Ruska & Borries, Siemens社	UM-100 (100kV, x30,000, 7nm)
	(JSTS) 第37小委員会 (Shoji Seto)	
1940	M. V. Ardenne	分解能3nm
	H. Rusk	バクテリアファージの電顕像
	H. Boersch	フレネル縞
	浅尾莊一郎	x100 (東芝)
1941	Seimens	UM-220 (220kV, 2nm)
1943	Hitachi	HU-2 (名古屋大学)
1946	J. Hillier & E. G. Ramberg	非点収差補正で1.1nm
1948	D. Gabor	ホログラフィ
1949	Japanese Electron Microscopy Society 日本電子顕微鏡学会設立	
1954	Seimens	Elmiskop I (100kV, <1nm)
1956	J. W. Menter	白金フタロシアニン (1.19nm)
	G. Möllenstedt & H. Düker	電子線バイプリズムの開発
1960	T. H. Maiman	レーザーの発明(ルビーレーザー)
1962	E.N.Leith & J. Upatnieks	二光束(off-axis)ホログラフィーの考案
1968	A. V. Crew et al.	FE-SEM, 単原子像
1979	A. Tonomura et al.	FE-TEM, 電子線ホログラフィ

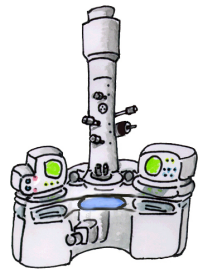

Dennis Gabor (1900 - 1979)



D. Gabor

Nature, 1948

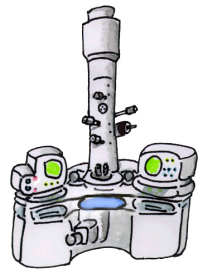

Contents

1. Introduction
2. Interference of waves
3. Electron holography
 - High resolution imaging
 - Observation of Magnetic field
5. Stereoscopic TEM
6. Phase plate using A-B effect

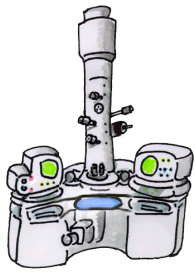

Interference of Light

Interference with double slits

Thomas Yang (Eng.1773-1829)

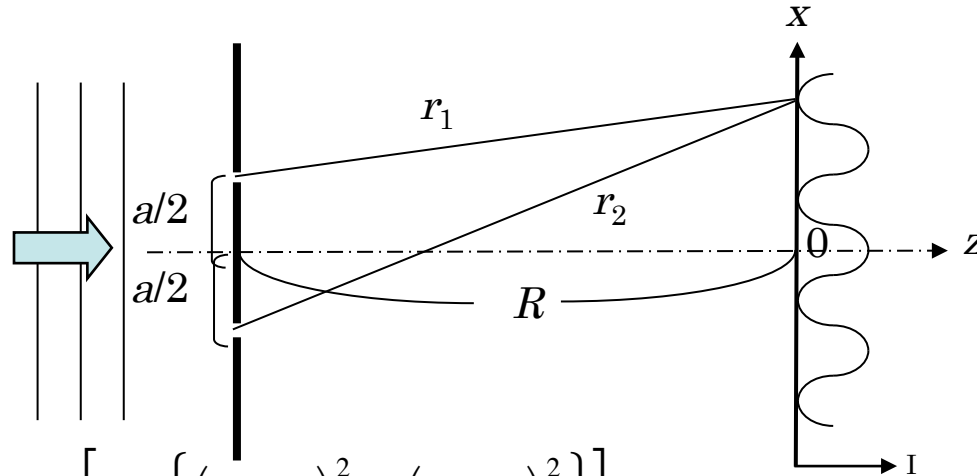

$$\begin{aligned}
 I &= \cos \left[\frac{2\pi}{\lambda} \left(\frac{x + \frac{a}{2}}{2R} \right) \right] \cos \left[\frac{2\pi}{\lambda} \left(\frac{x - \frac{a}{2}}{2R} \right) \right] \\
 &= 2 \cos \left\{ \frac{2\pi}{\lambda} (r_1 - r_2) \right\} \\
 &= \cos \left(\frac{2\pi a x}{\lambda R} \right) \\
 &= \cos \left[\frac{2\pi a x}{\lambda R} \left[\left\{ \left(x + \frac{a}{2} \right)^2 + R^2 \right\}^{1/2} - \left\{ \left(x - \frac{a}{2} \right)^2 + R^2 \right\}^{1/2} \right] \right]
 \end{aligned}$$

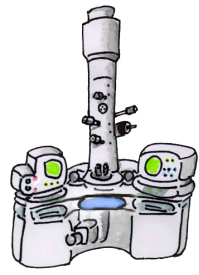

Interference of Light

Fresnel's Biprism (Augustin J. Fresnel:Fr.1788-1827)

Diffraction with a pin hole is not essential for Young's experiment

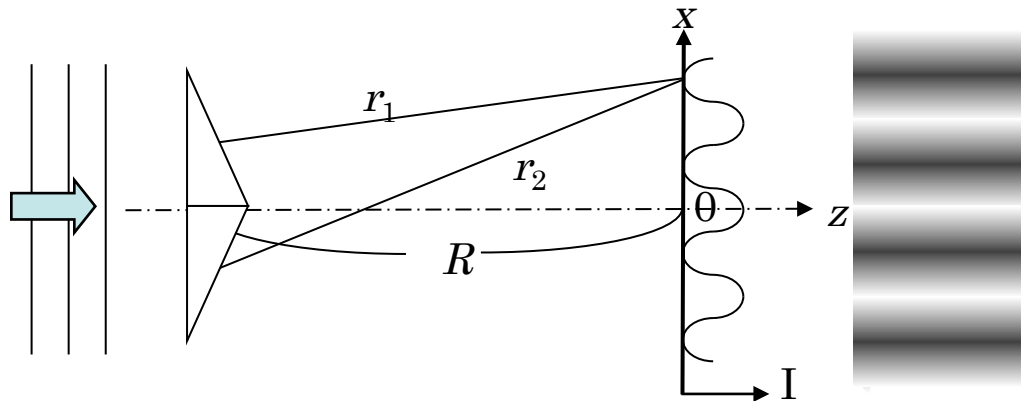

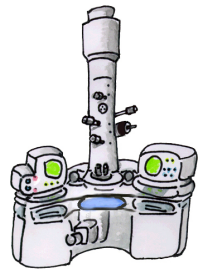

Interference of Electron Wave

Interference experiment with electrons

→ The core of quantum mechanics (R.P.Feynman)

Electron Biprism G. Möllenstedt and H. Düker, Z. Phys. **145** (1956) 377.

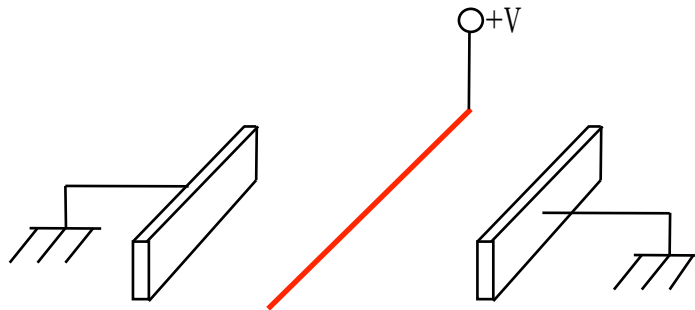

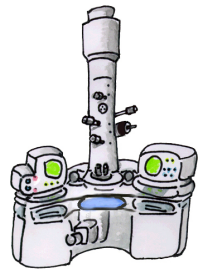

Electron Biprism

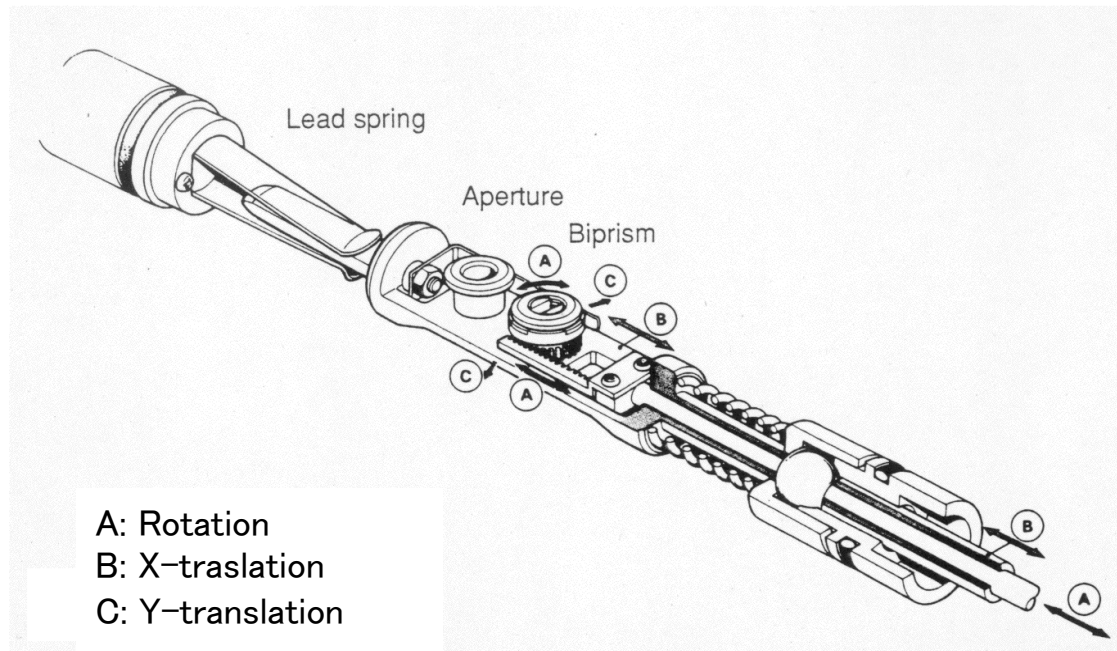

Hitachi

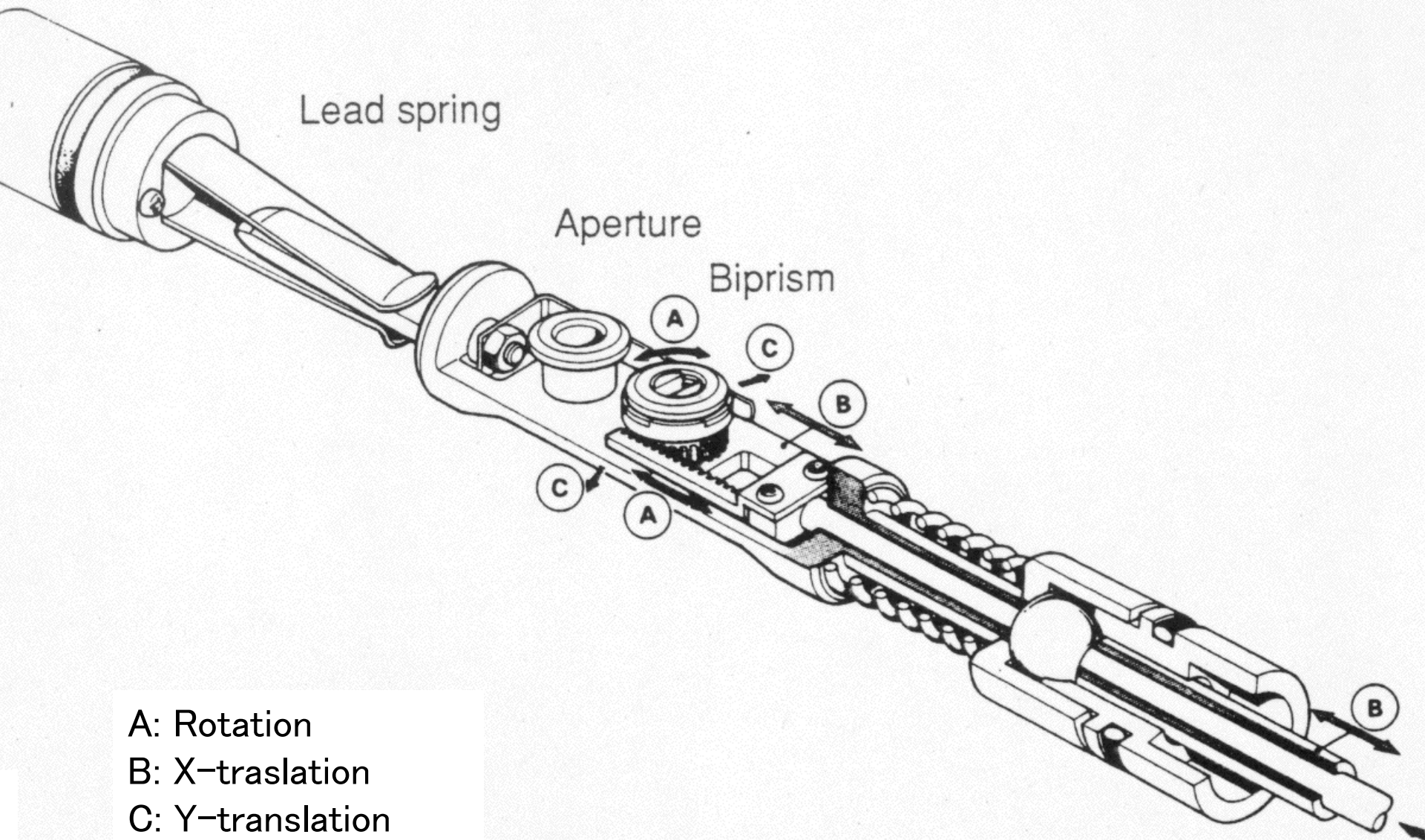

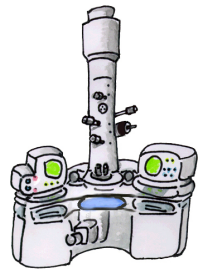

Making Filaments of Biprism

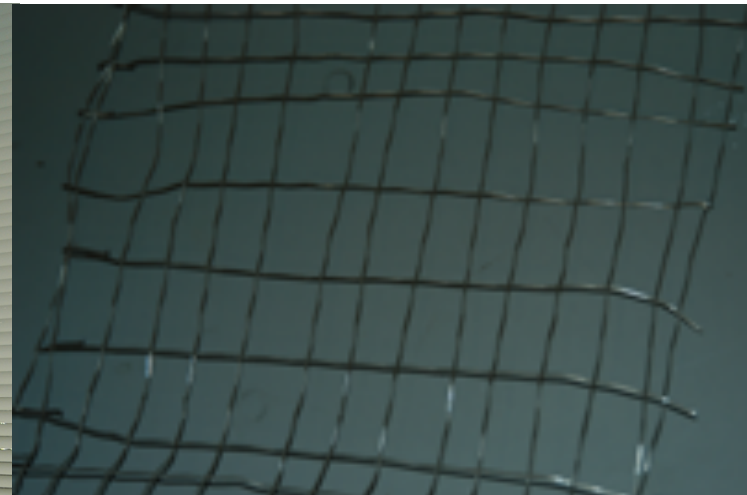
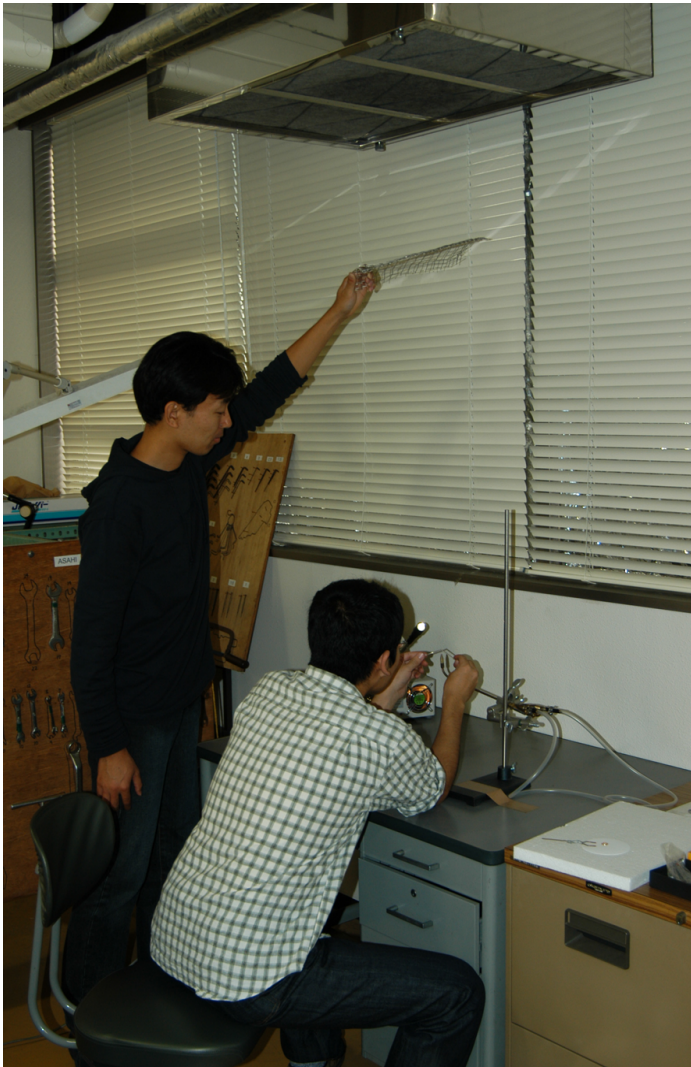

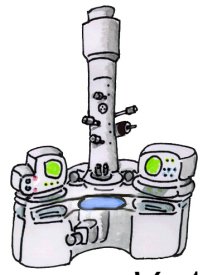

Interference of the Electron Wave

$V_f = 15 \text{ V}$

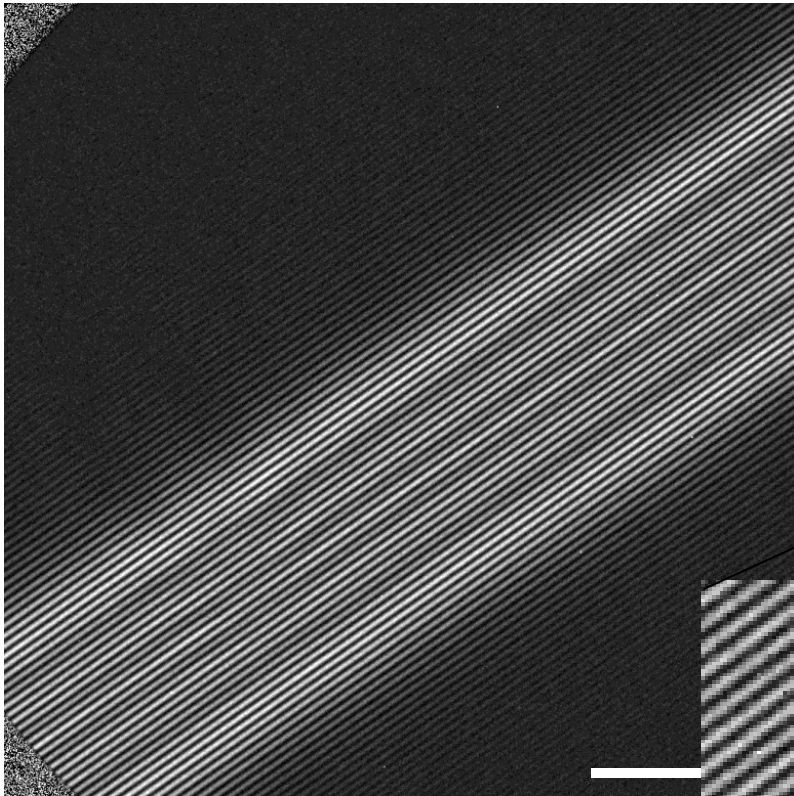

Interfering region: $\sim 20 \text{ nm}$

Fringe spacing: 0.90 nm

$V_f = 30 \text{ V}$

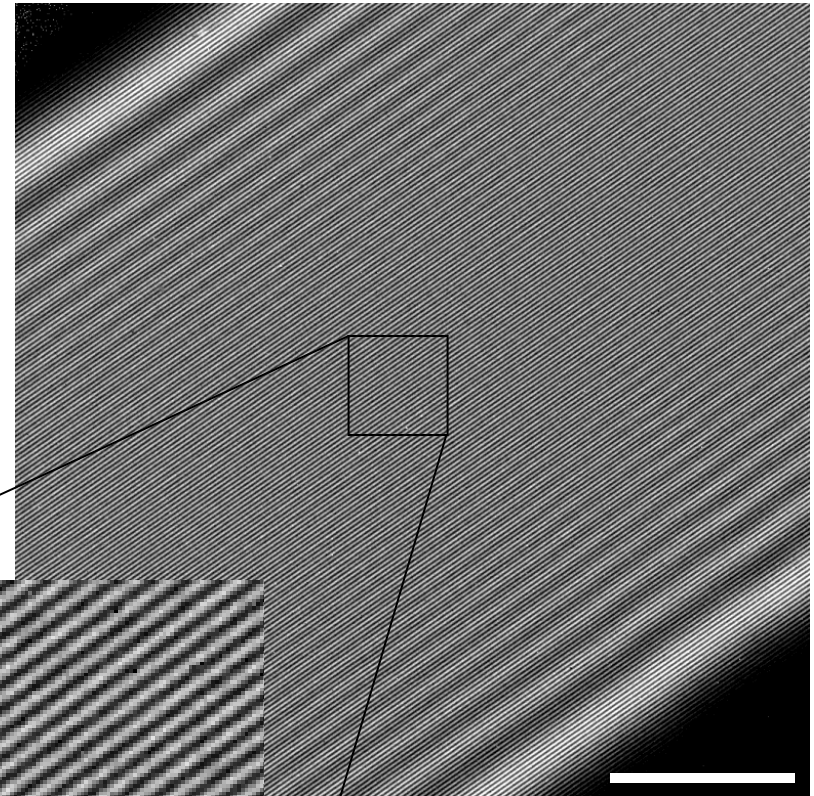

Interfering region: $\sim 83 \text{ nm}$

Fringe spacing: 0.44 nm

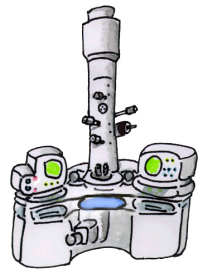

Contents

1. Introduction
2. Interference of waves
3. Electron holography
 - High resolution imaging
 - Observation of Magnetic field
5. Stereoscopic TEM
6. Phase plate using A-B effect

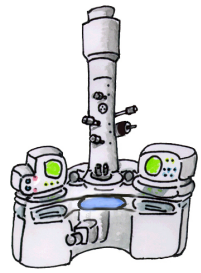

Holography

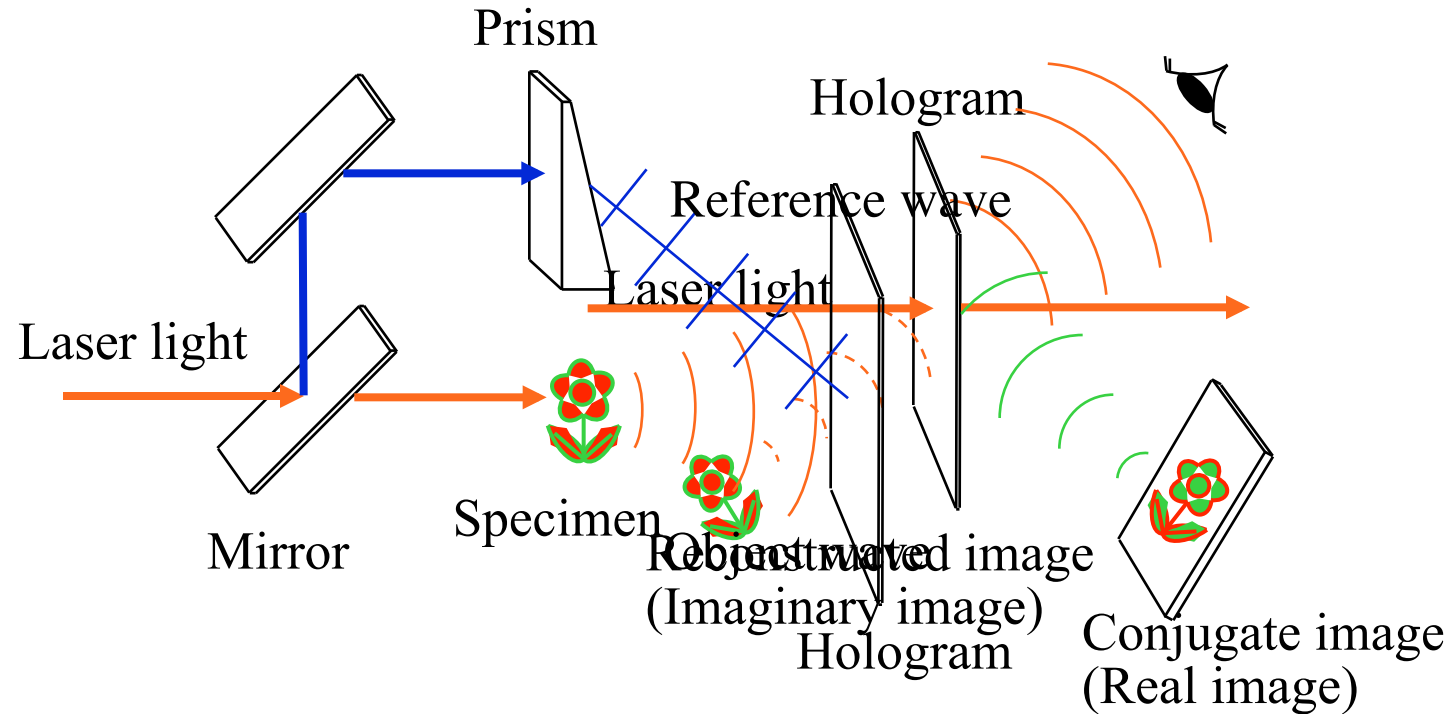

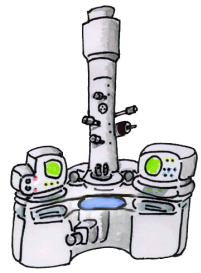

Electron Holography

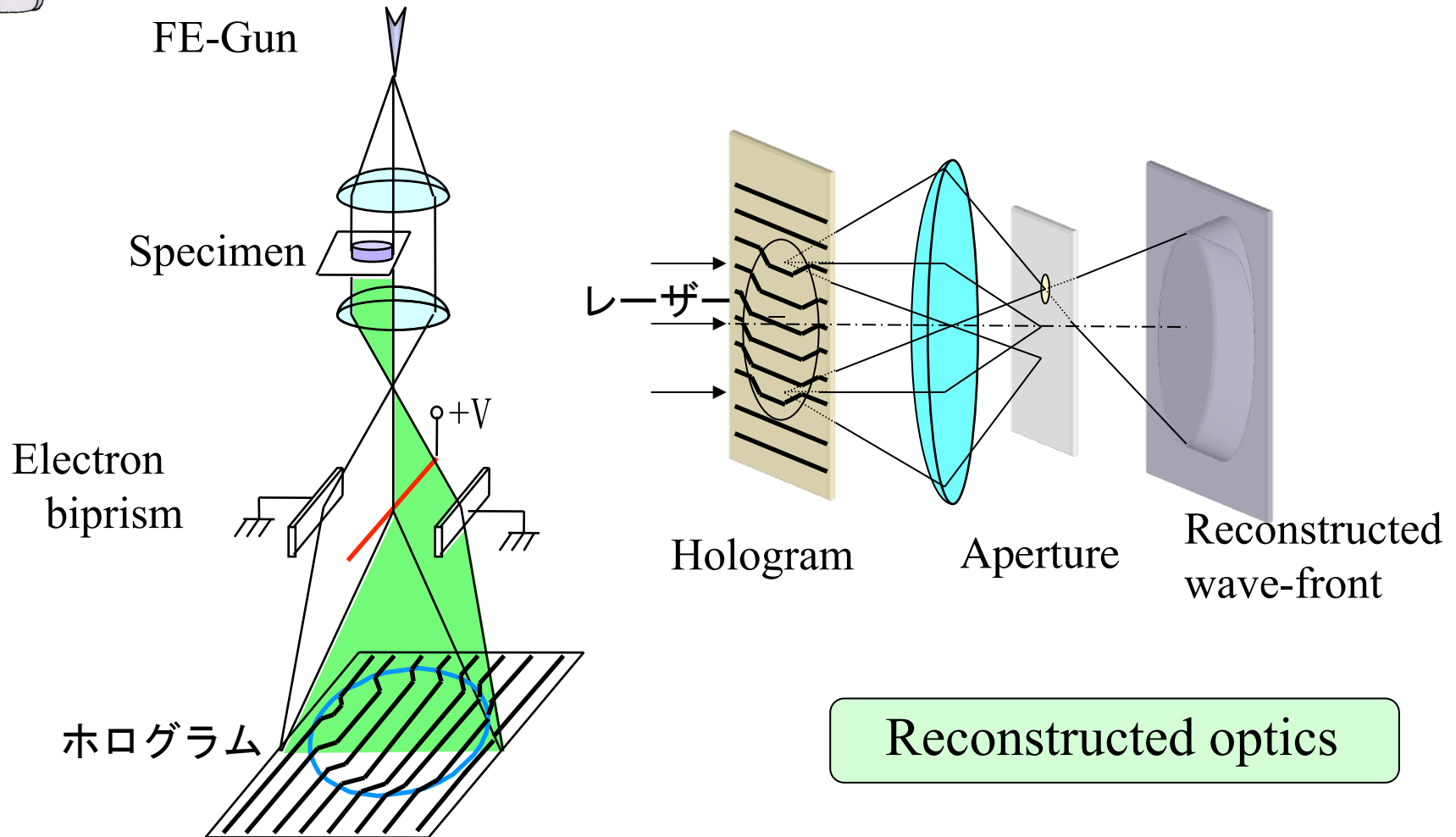

Recording of a hologram

Reconstructed optics

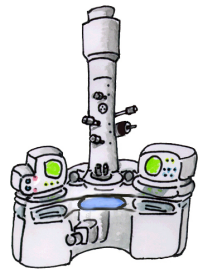

Interference Microscopy

(Machzender Interferometer)

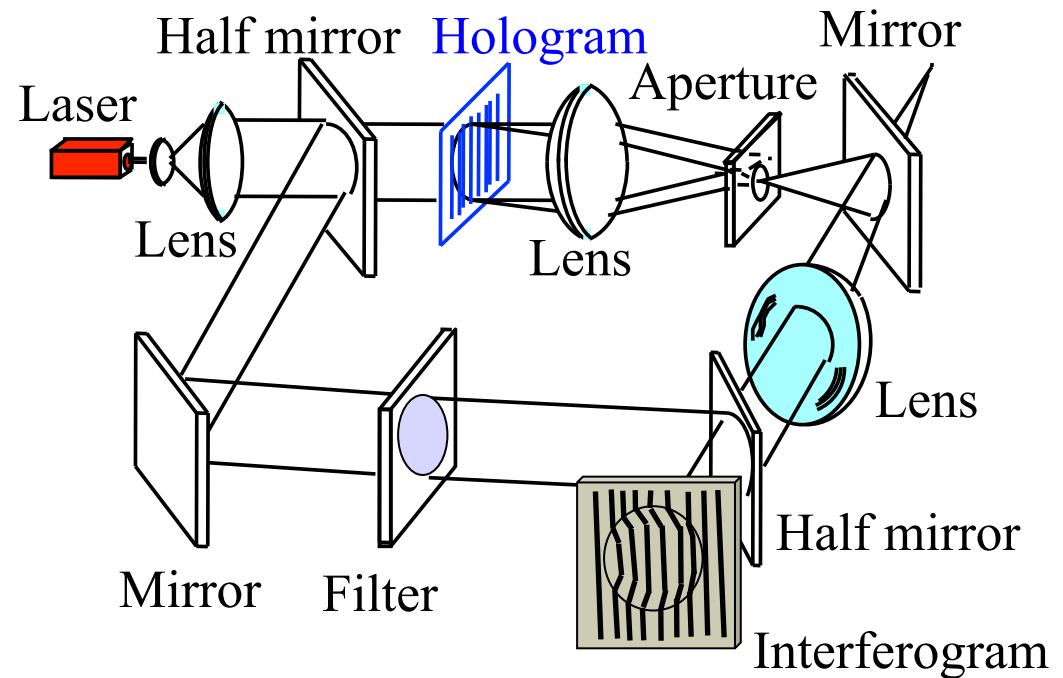
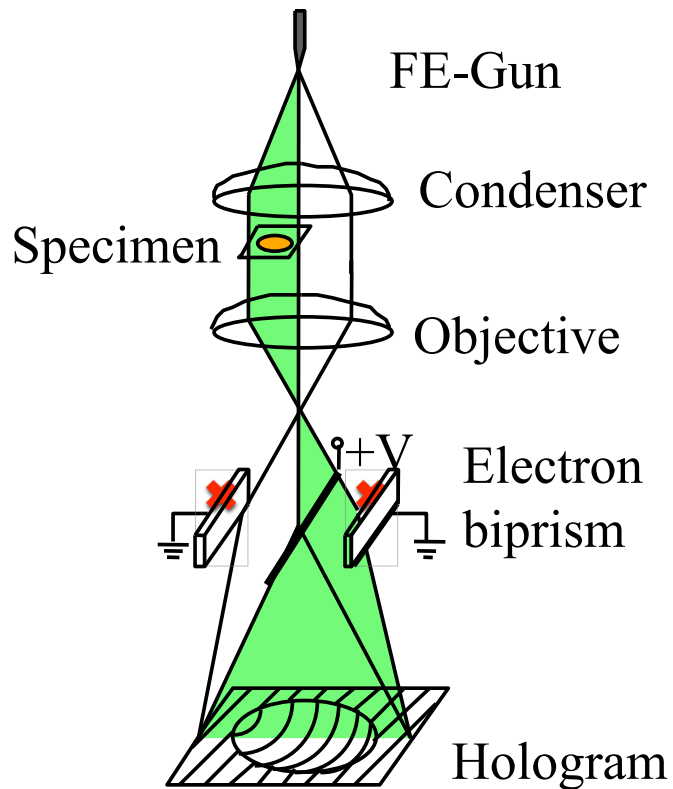

Interference micrograph

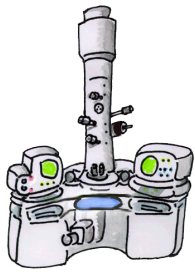

Digital Reconstruction

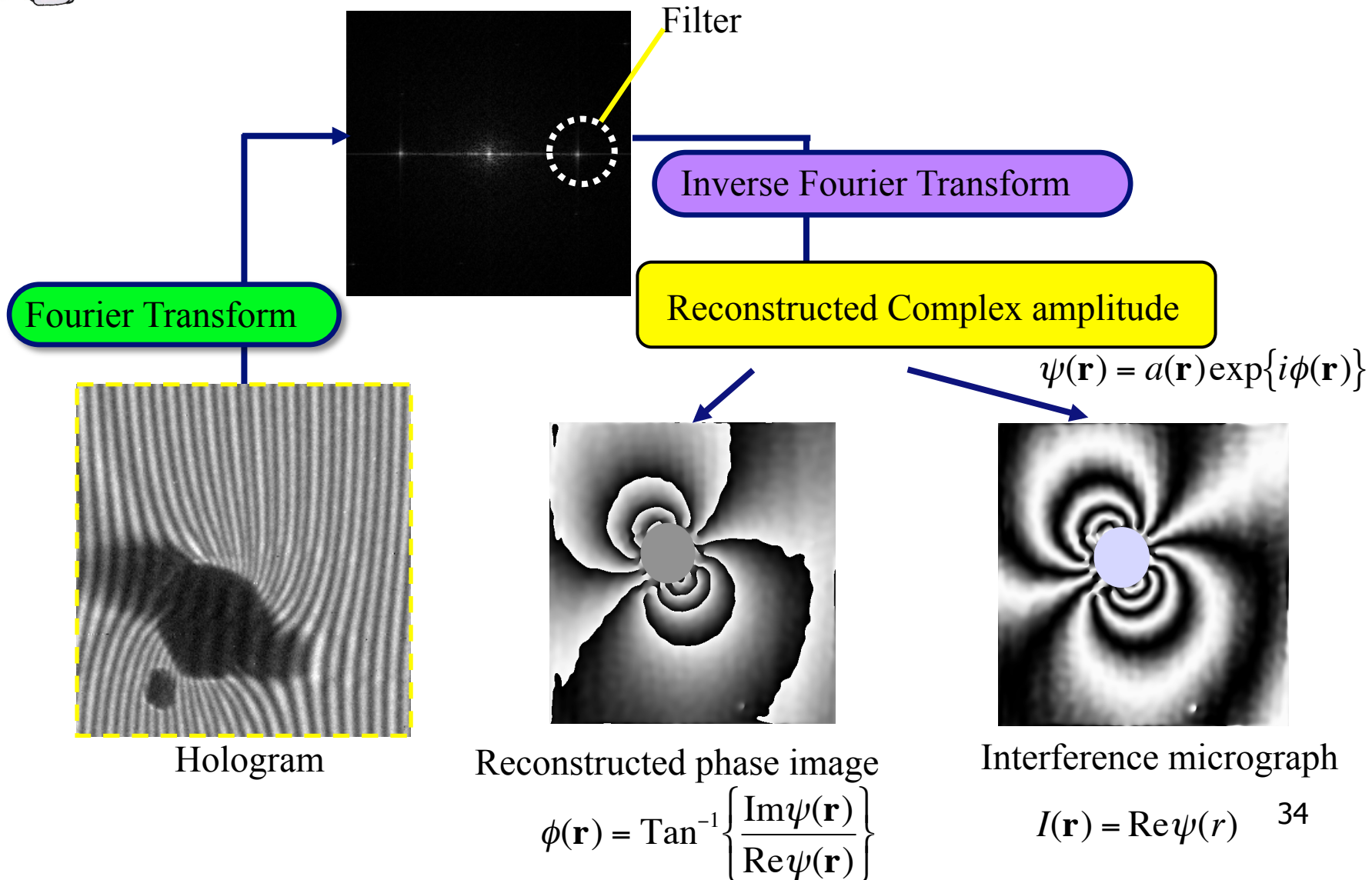

Phase Shift of Electrons by the Electromagnetic Field

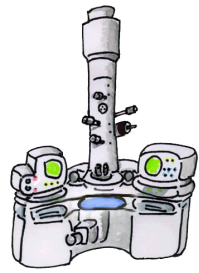

Schrödinger Eq.
$$\left(\frac{\hbar}{i} \text{grad} + e\mathbf{A} \right)^2 \Psi - 2m(E - eV)\Psi = 0$$

▪ WKB approx. & $E \ll eV$

if
$$\Psi(\mathbf{r}) = a(\mathbf{r}) \exp\{i\phi(\mathbf{r})\} \exp\{i(\omega t - \mathbf{k} \cdot \mathbf{r})\}$$

Phase shift by an electrostatic potential

$$\Delta\phi = \frac{\pi}{\lambda E} \int_z V(x, y, z) dz$$

Phase shift by a magnetic field

$$\Delta\phi = -\frac{e}{\hbar} \int_s \mathbf{B}(x, y, z) \cdot d\mathbf{S}$$

Phase Shift of Electrons by the Electromagnetic Field

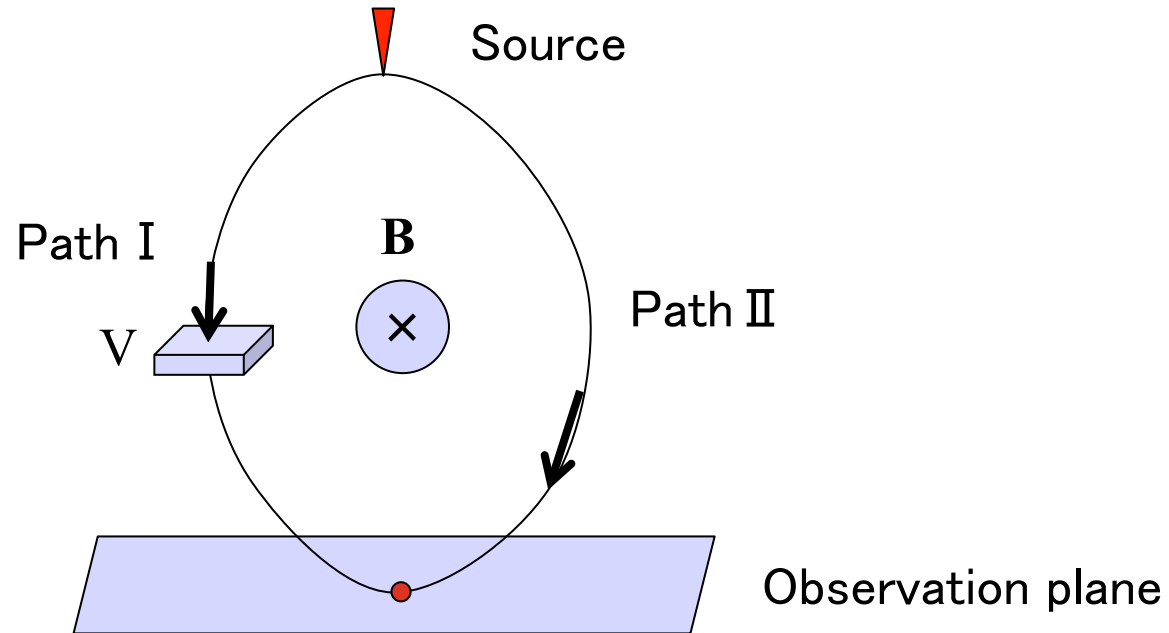
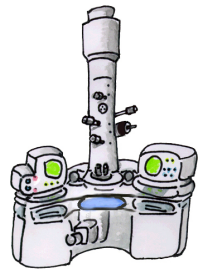

Phase shift by an electrostatic potential

$$\Delta\phi = \frac{\pi}{\lambda E} \int_z V(x, y, z) dz$$

Phase shift by a magnetic field

$$\Delta\phi = -\frac{e}{\hbar} \int_S \mathbf{B}(x, y, z) \cdot d\mathbf{S}$$

Phase Shift of Electrons by the Electromagnetic Field

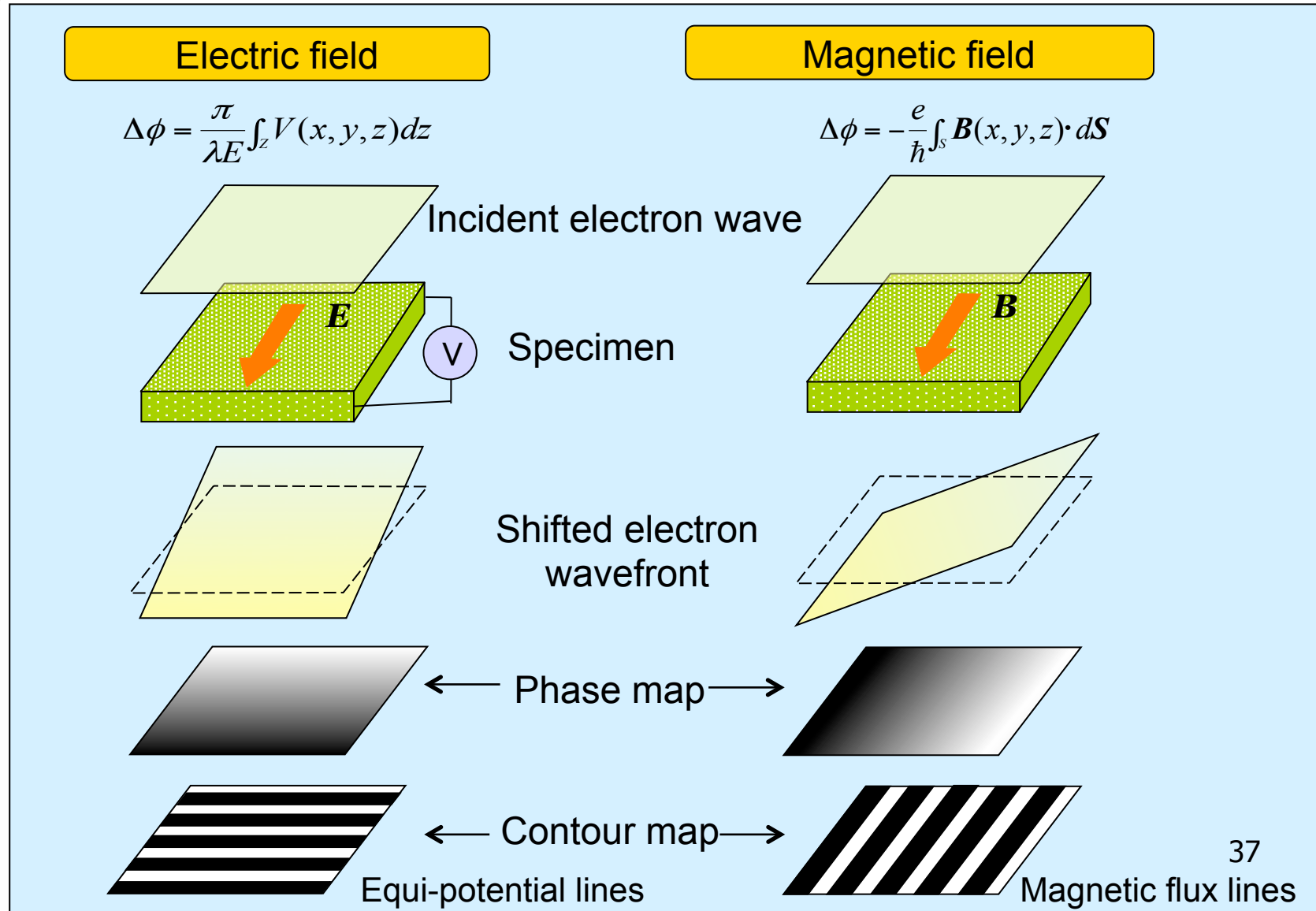
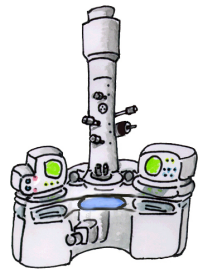

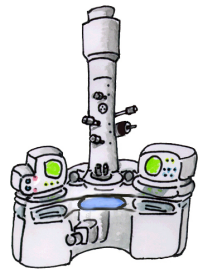

Latex Particle Charged Up

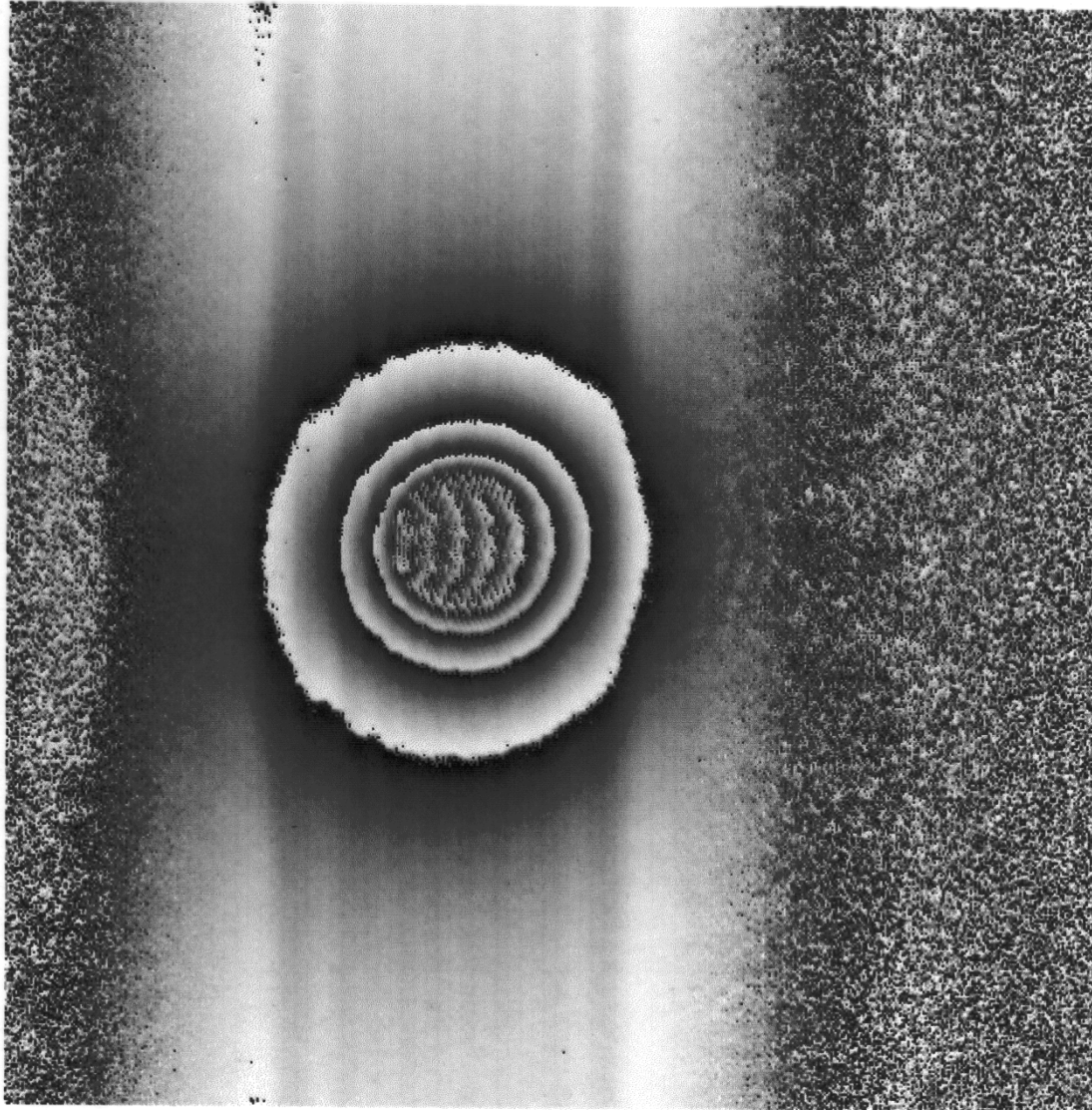

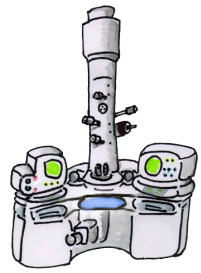

Single Magnetic Domain Particle of Ba-Ferrite

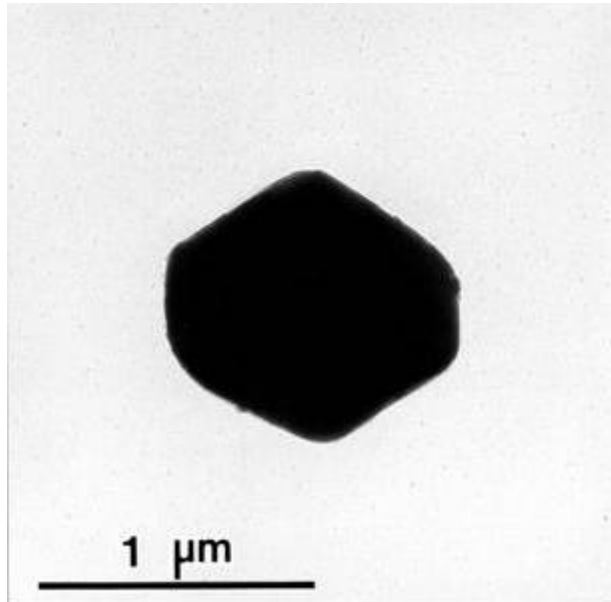

TEM Image

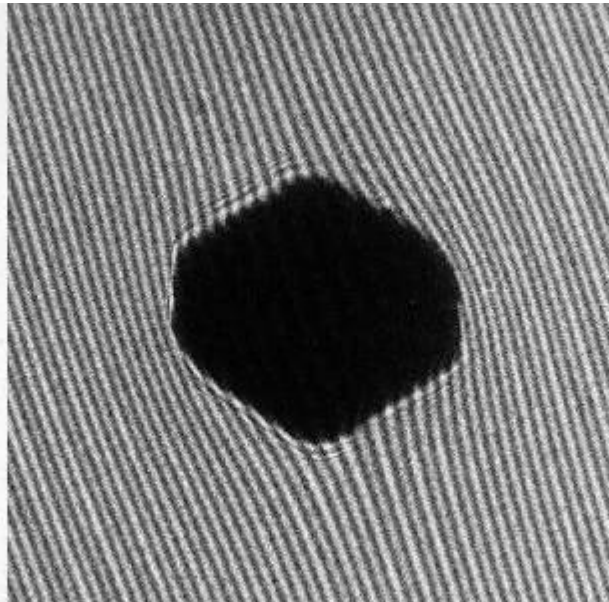

Hologram

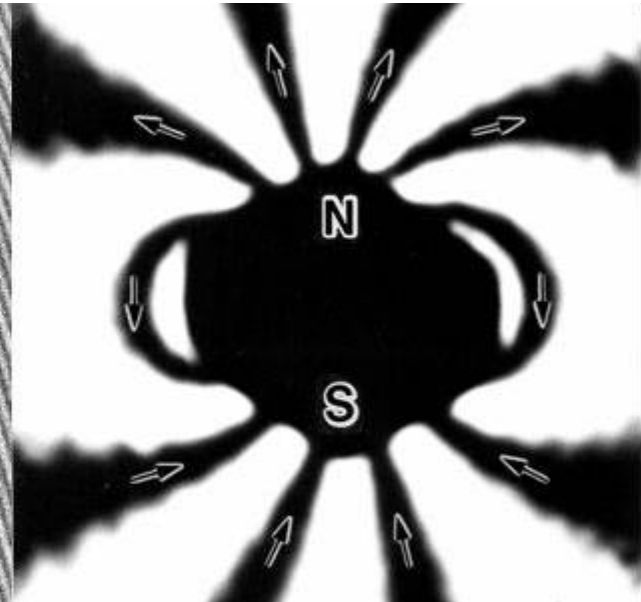

Interference image

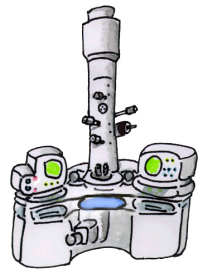

Contents

1. Introduction
2. Interference of waves
3. Electron holography
 - High resolution imaging
 - *In situ* observation of SOFC
5. Stereoscopic TEM
6. Phase plate using A-B effect

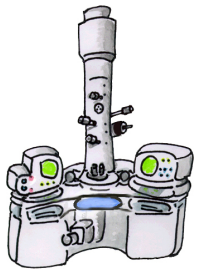

内部電位による電子の位相変化

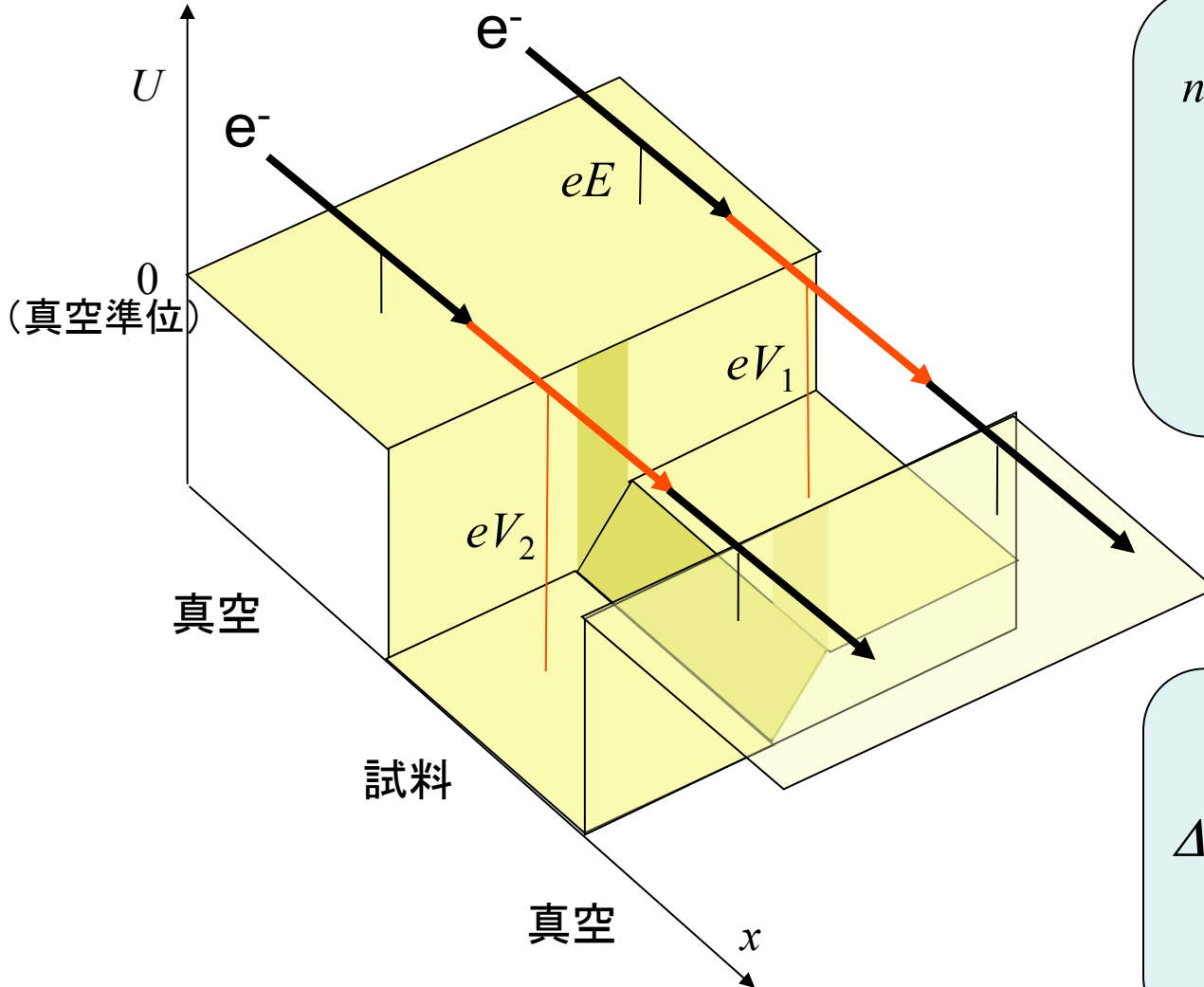

$$n = \frac{\lambda_0}{\lambda_1} = \sqrt{\frac{e(E+V)^*}{eE^*}}$$

$$= 1 + \frac{V}{2E} \left(\frac{1 + \frac{eE}{mc^2}}{1 + \frac{eE}{2mc^2}} \right)$$

$$\Delta\phi = \frac{2\pi kVd}{2E} \left(\frac{1 + \frac{eE}{mc^2}}{1 + \frac{eE}{2mc^2}} \right)$$

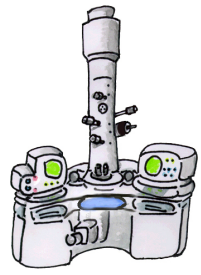

波長の変化とホログラム

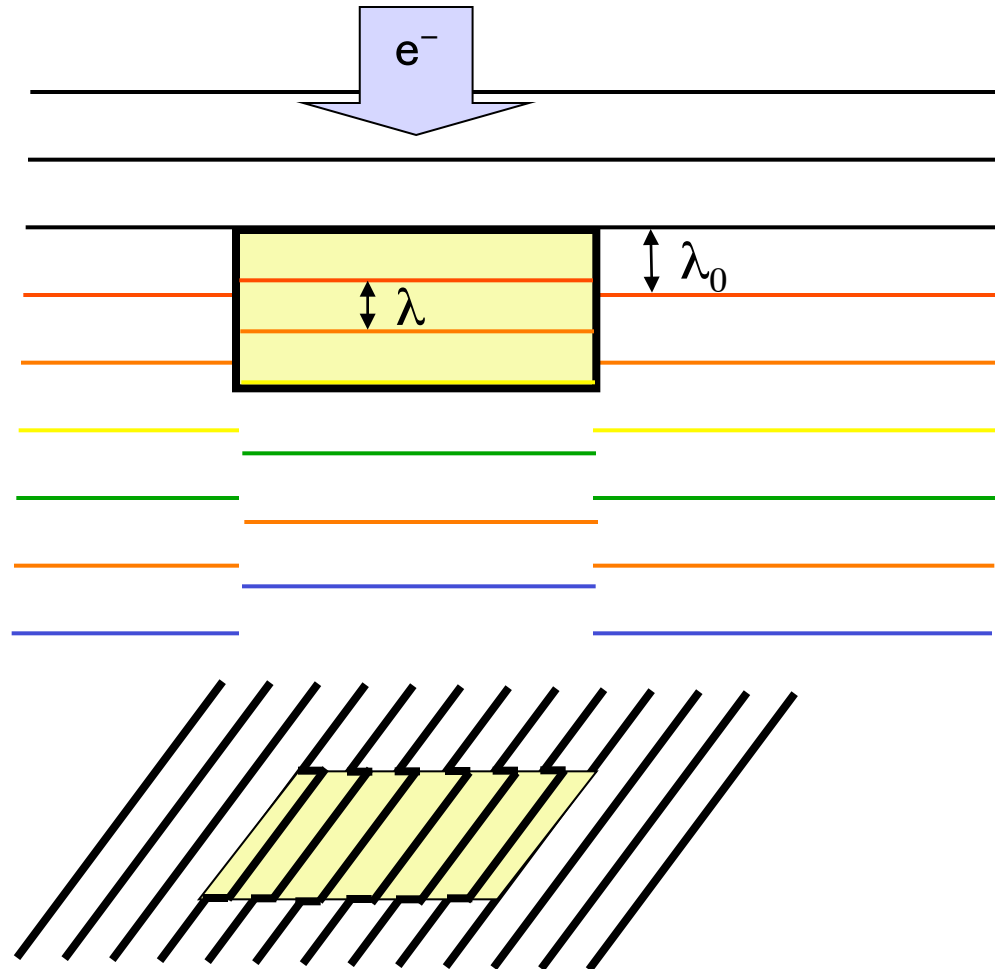

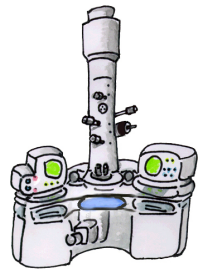

Electron Hologram of MgO

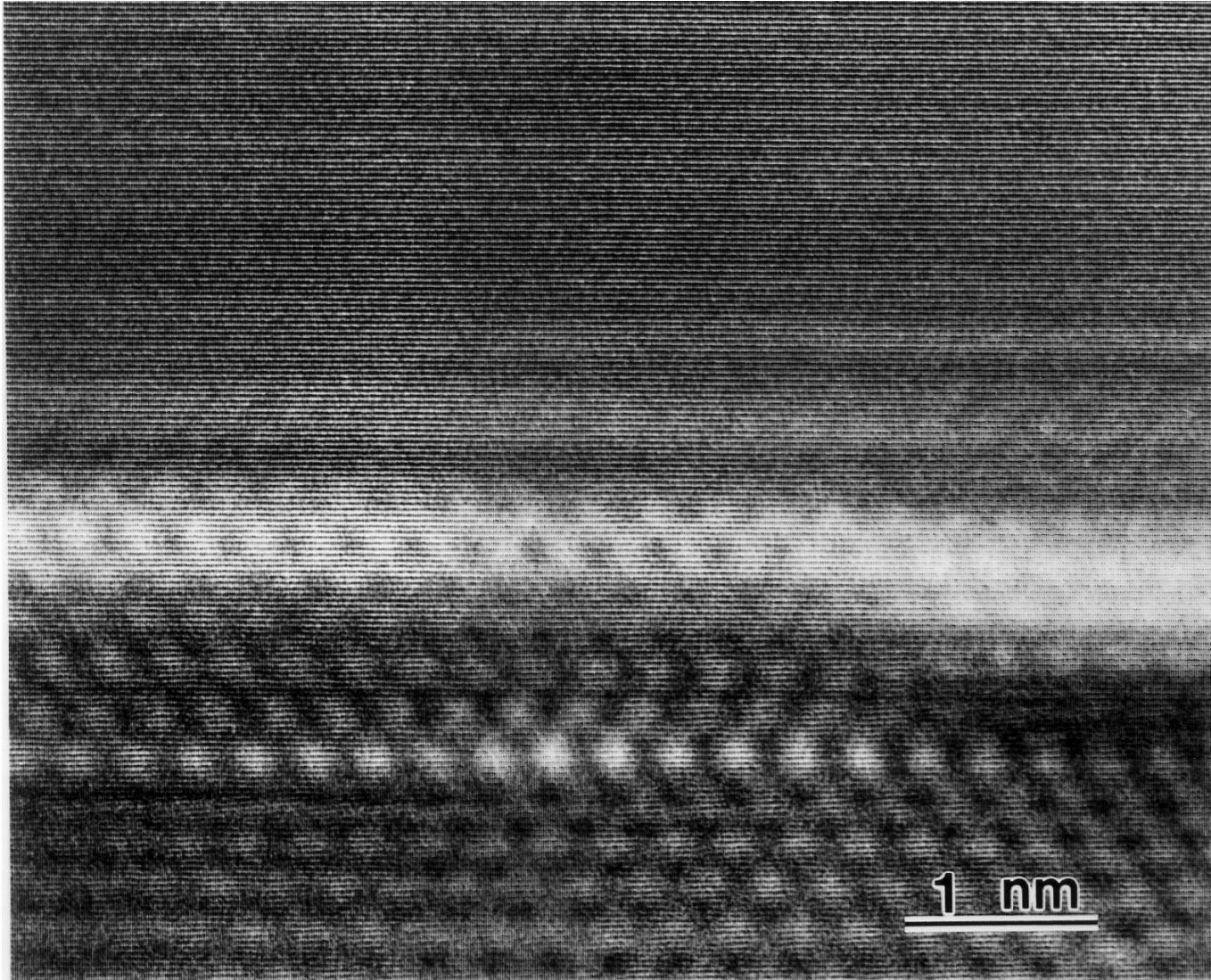

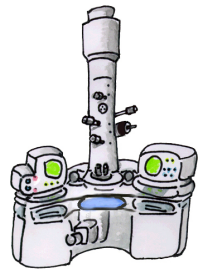

MgOホログラムのFourier変換像

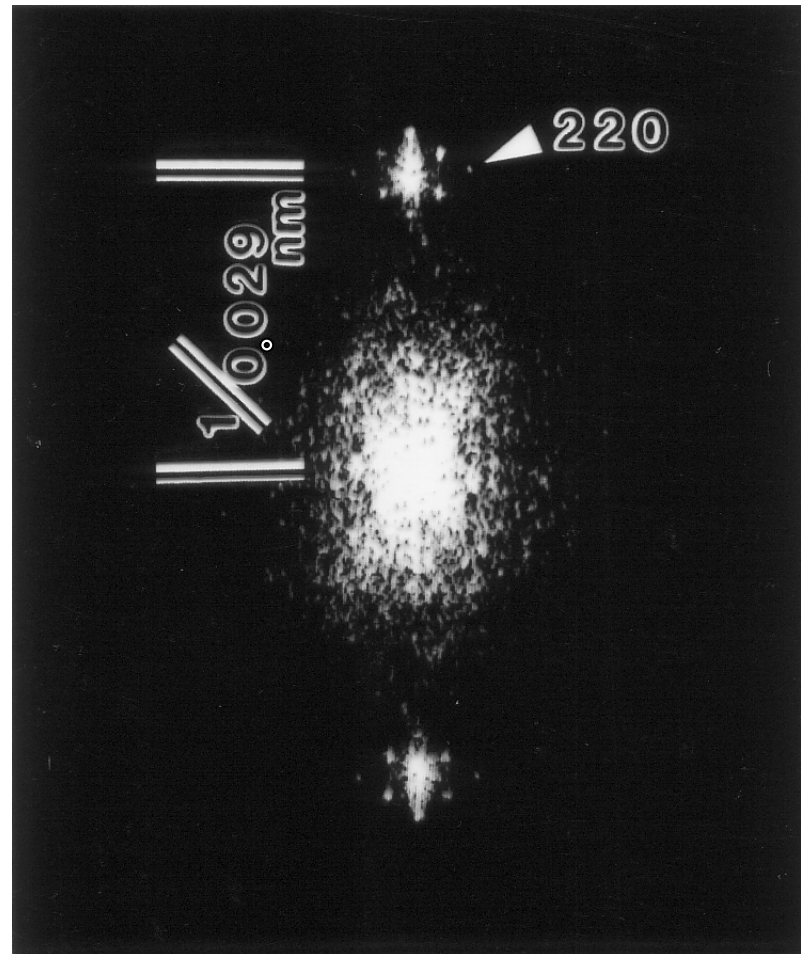

MgO [110] 表面の電子線ホログラフィー

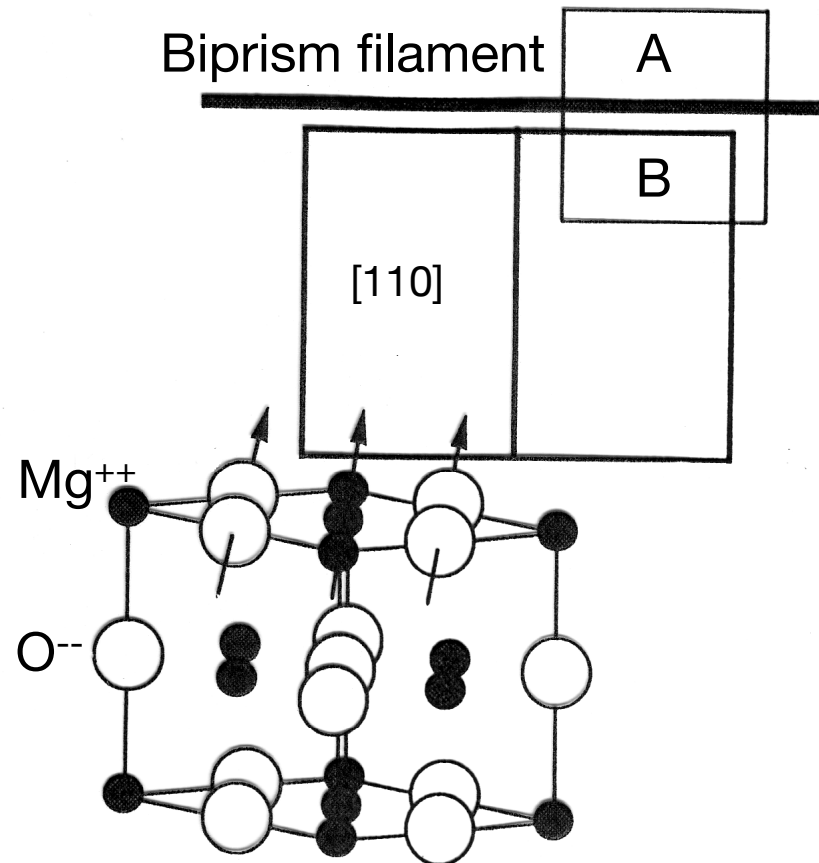
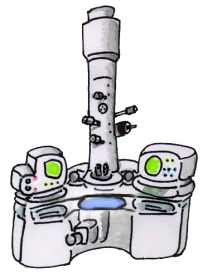

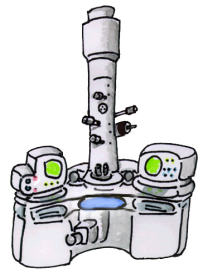

MgO (001) 表面

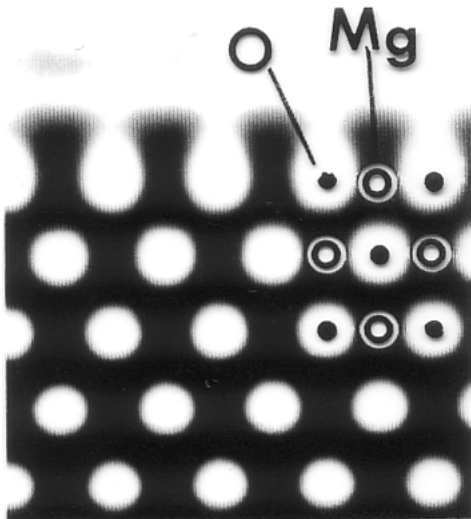

Simulation t=10nm

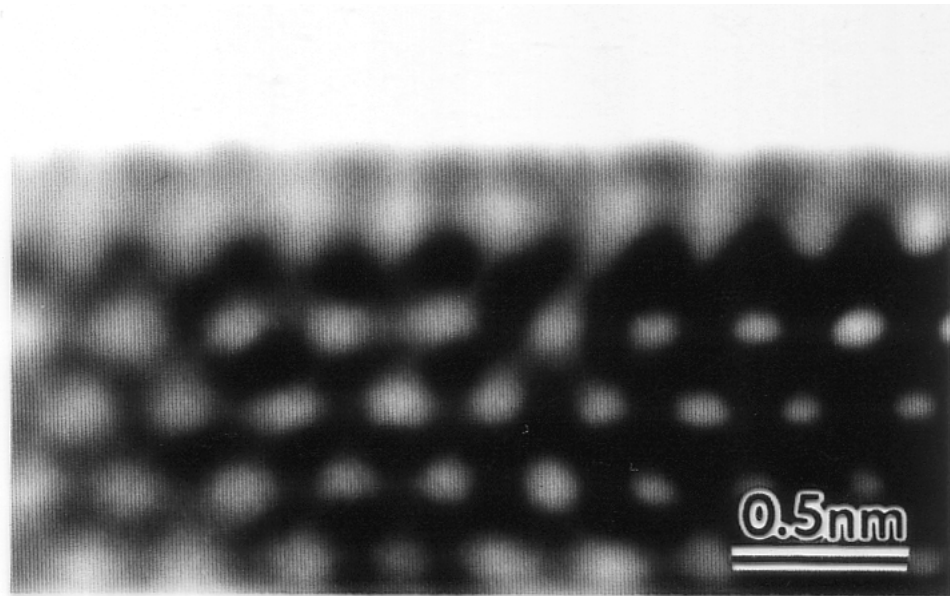

Reconstructed Phase

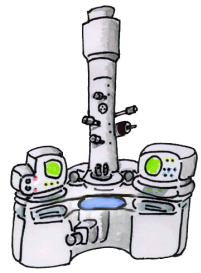

MgO (001) の表面ポテンシャル

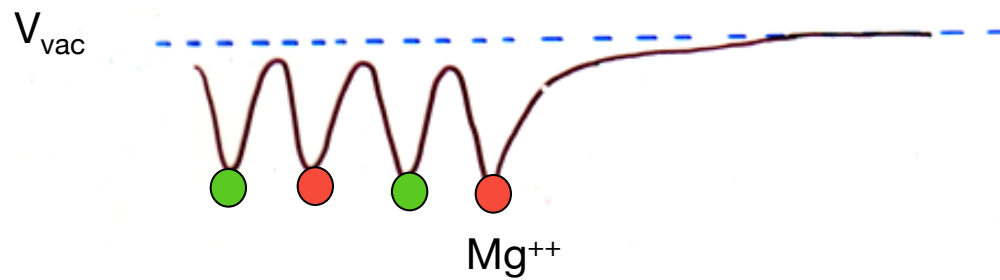
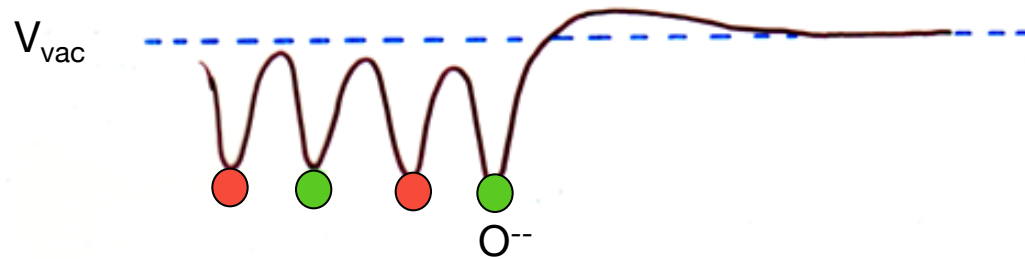

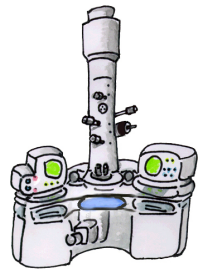

Contents

1. Introduction
2. Interference of waves
3. Electron holography
 - High resolution imaging
 - Observation of magnetic field
5. Stereoscopic TEM
6. Phase plate using A-B effect

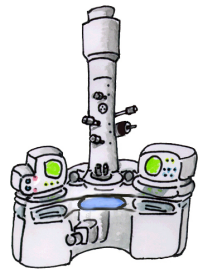

Low-Magnetic-Field Objective Lens

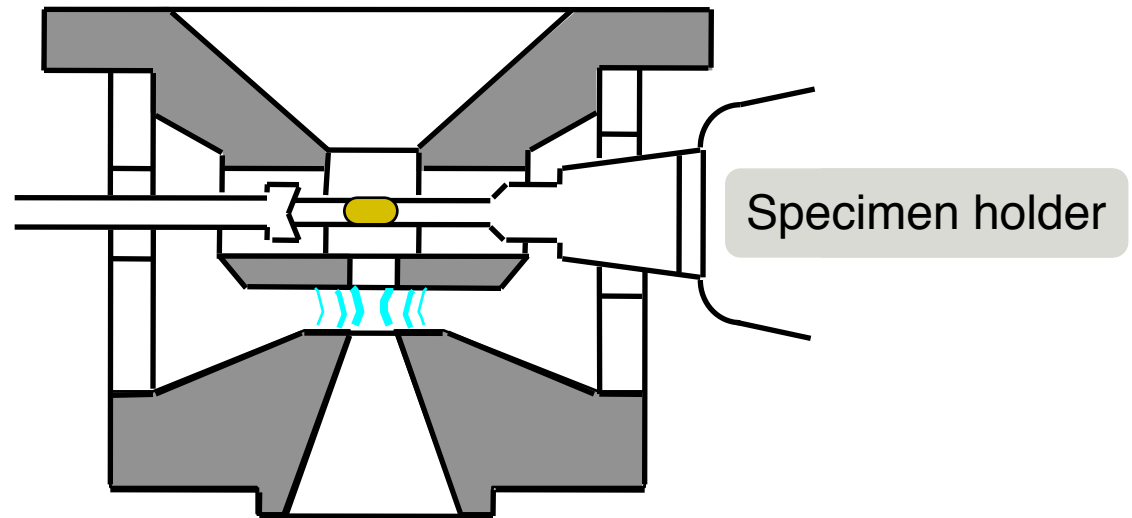

$B > 1T$ T , $x 1K \sim 500K$

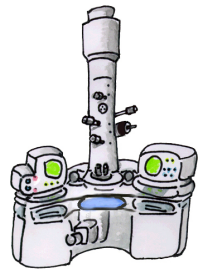

Magnetic Domain in a Permalloy Thin Film

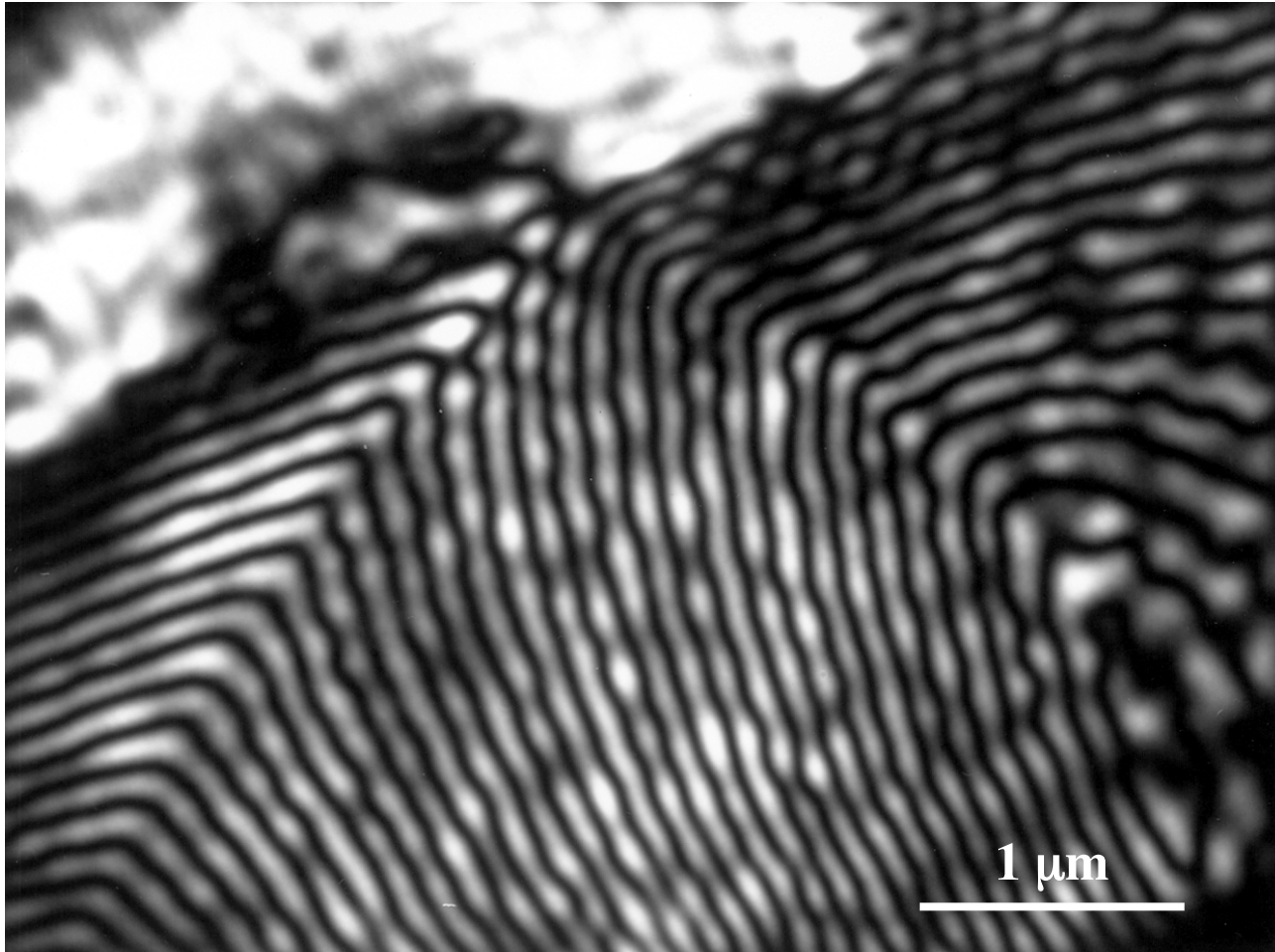

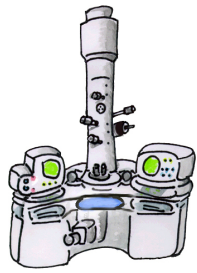

Real-Time electron Holography

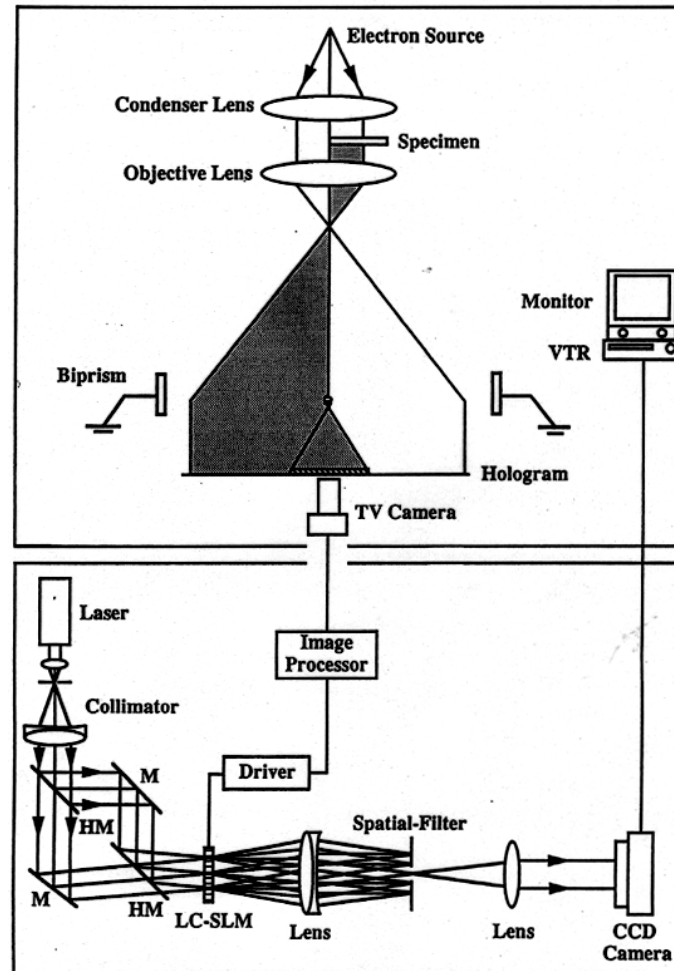

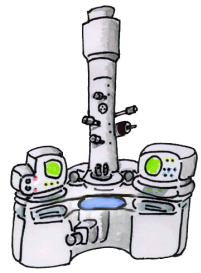

Real-time Observation of Magnetic Domain

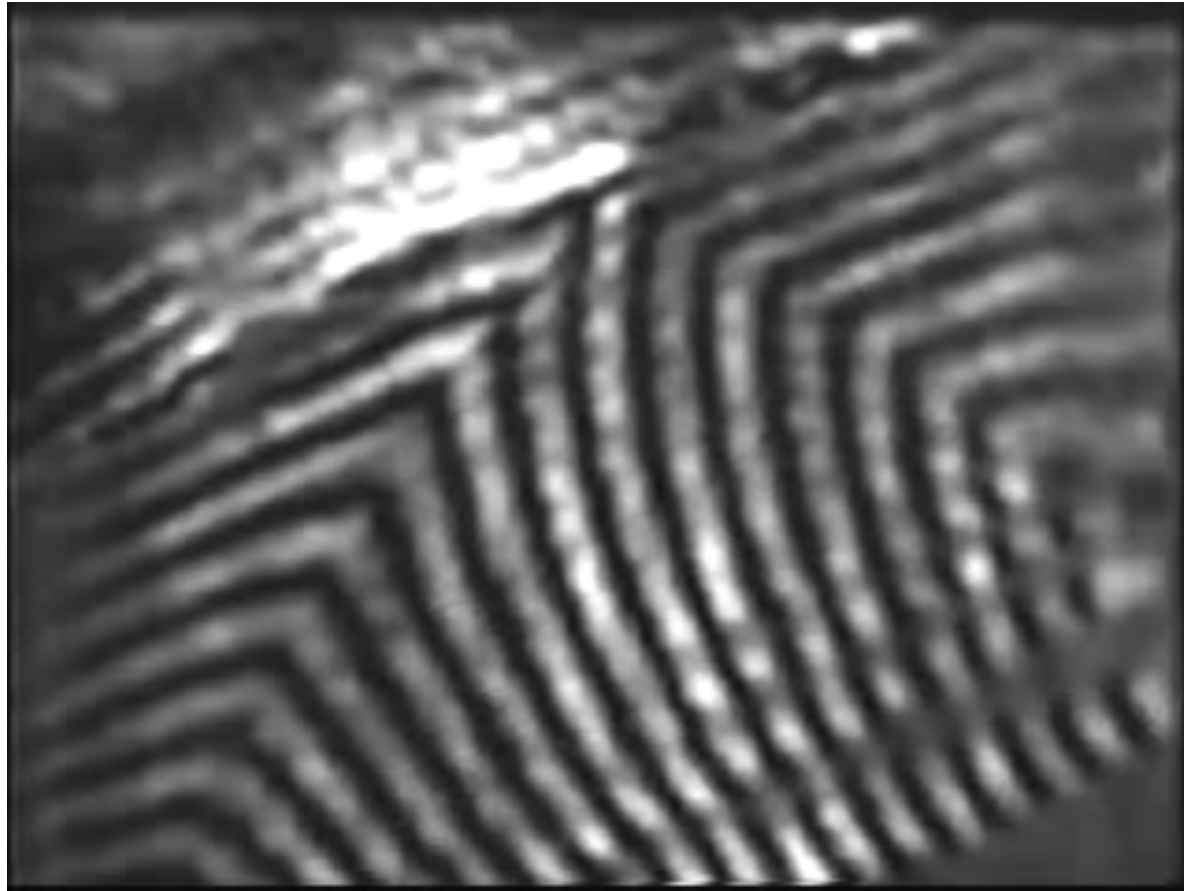

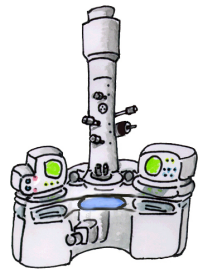

Real-time Observation of Magnetic Domain

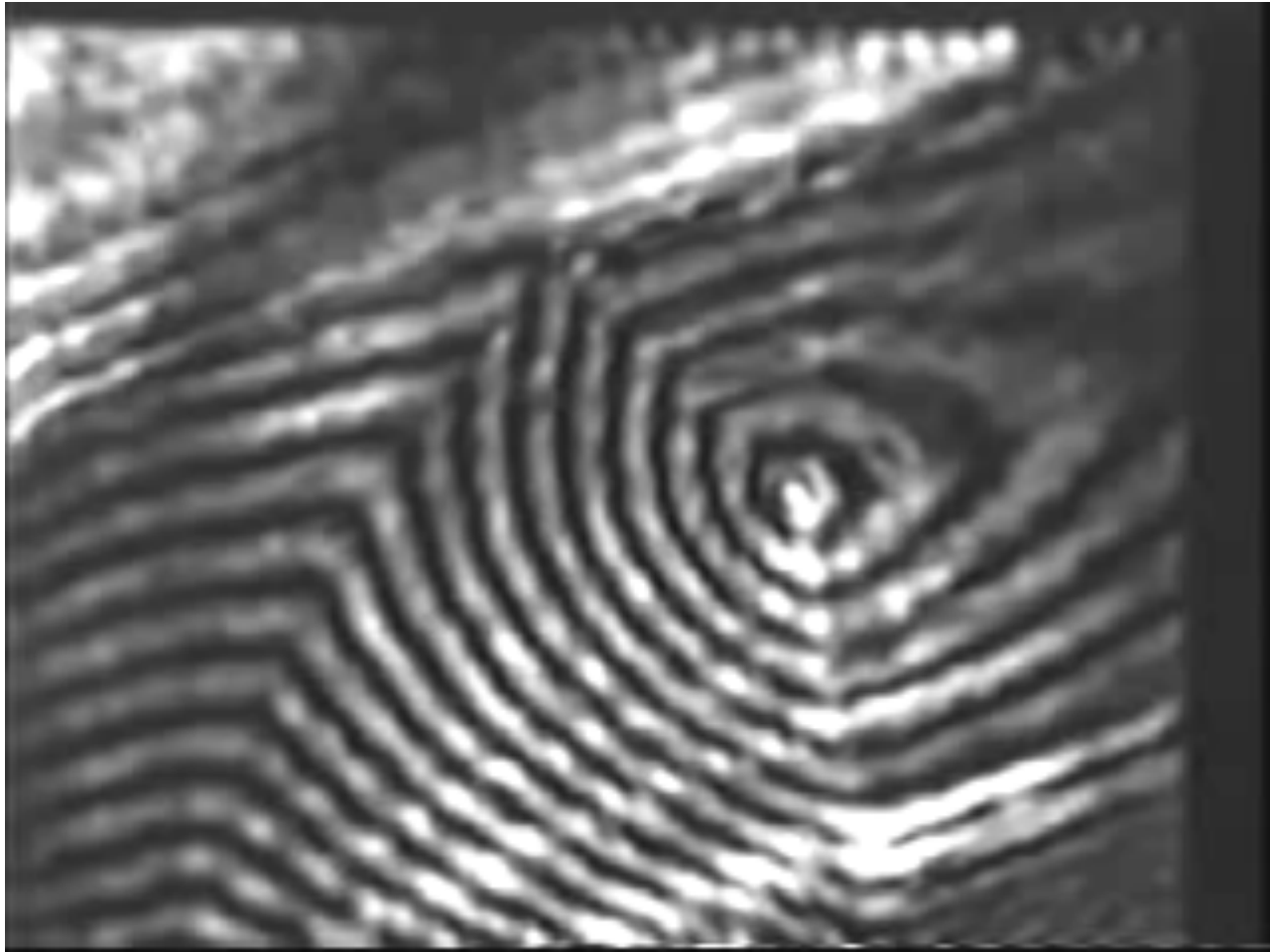

Magnetic Structure in a Permalloy Thin Film

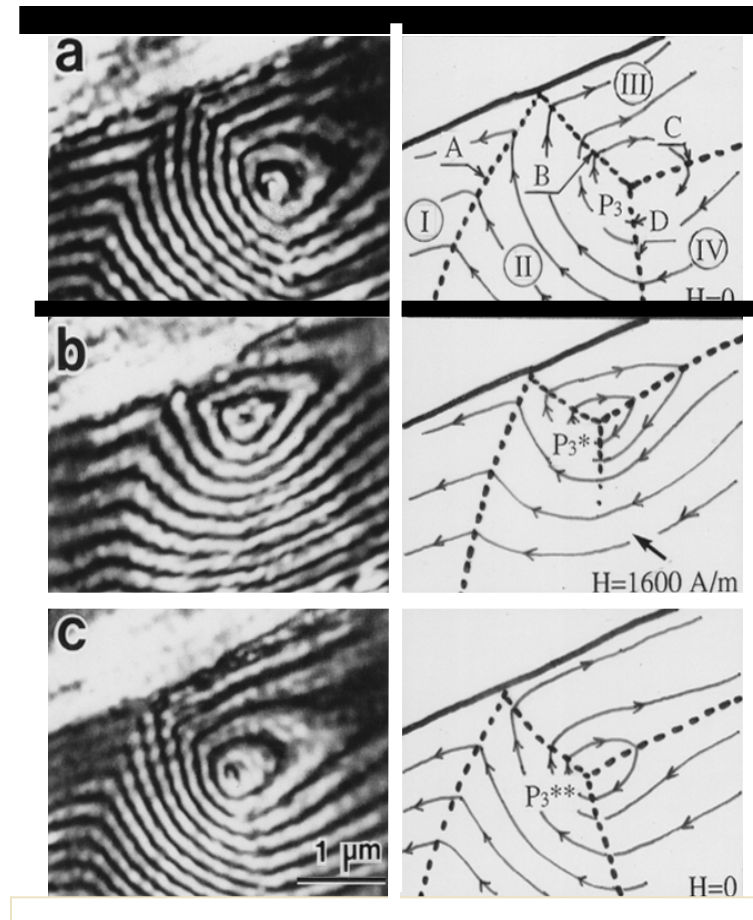
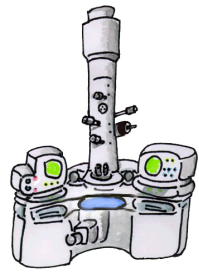

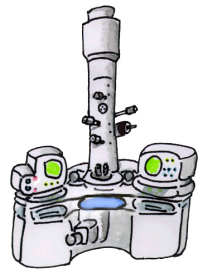

Contents

1. Introduction
2. Interference of waves
3. Electron holography
 - High resolution imaging
 - Observation of Magnetic field
5. Stereoscopic TEM
6. Phase plate using A-B effect

Development of a Real-Time Stereo Transmission Electron Microscope

- Real-Time Observation: Deformation, Crystal growth, Dislocation
- 3D Observation: Defect, Radiation damage, Cell

➔ Stereoscopy, Computer Tomography

~~Recording time, Computation time~~ for RT

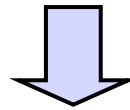

Real-Time 3D TEM

➔ Tilted Illumination Stereo Microscopy

- D. Typke et al. Proc. 6th EUREM (1976) 334.
- J.M. Pawley Proc. 6th Int. Conf. on HVEM 4 (1980) 58.
- P.F.M. Teunis et al. J. Microscopy, 168 (1992) 275.
- G. Fan and M.H. Ellisman Ultramicroscopy 55 (1994) 155.

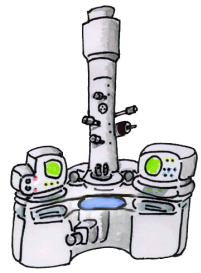

Real-Time Stereo TEM

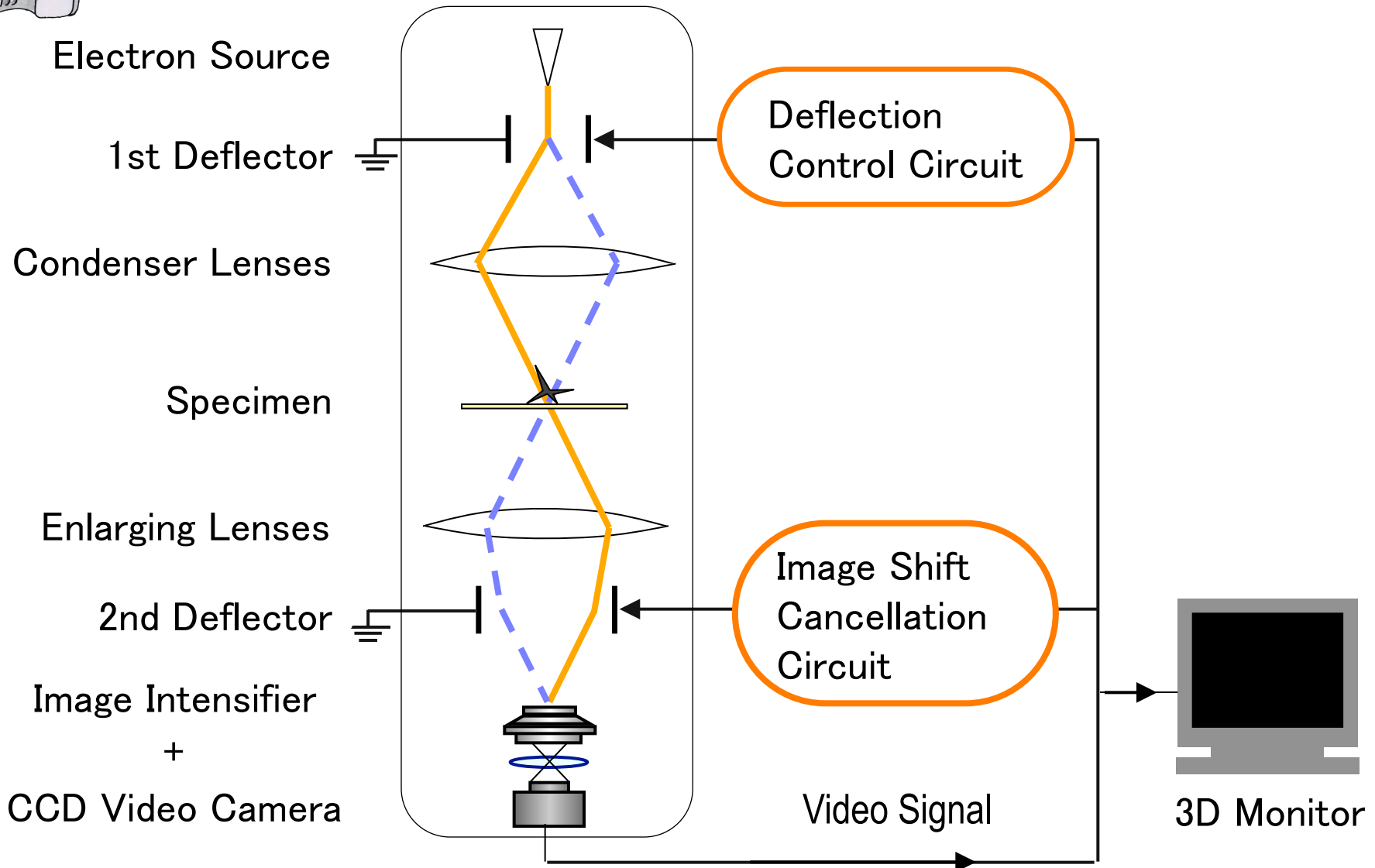

Real-Time Stereo TEM (HF-2000)

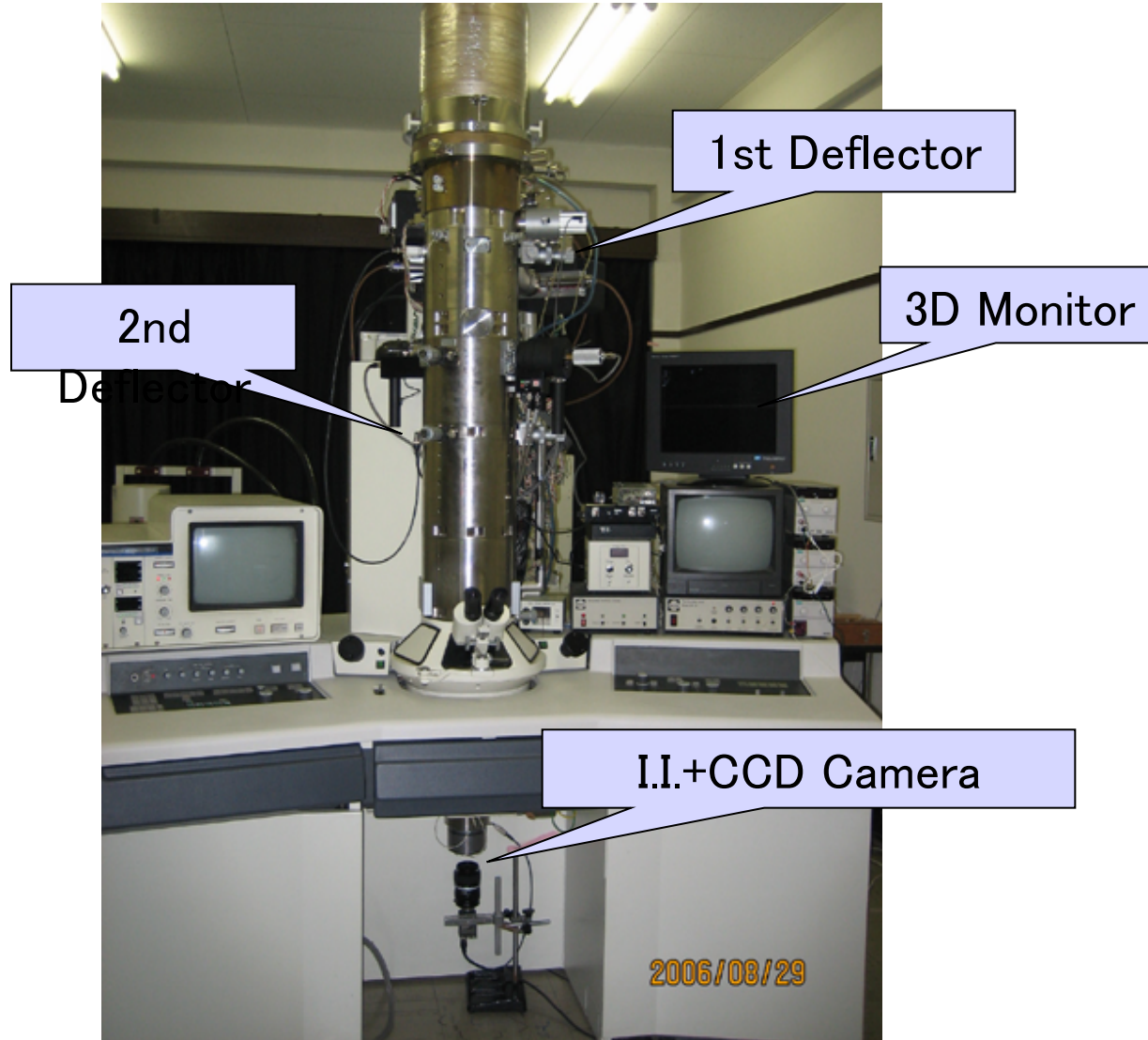
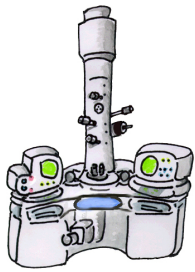

Video Signal and Deflector Potential

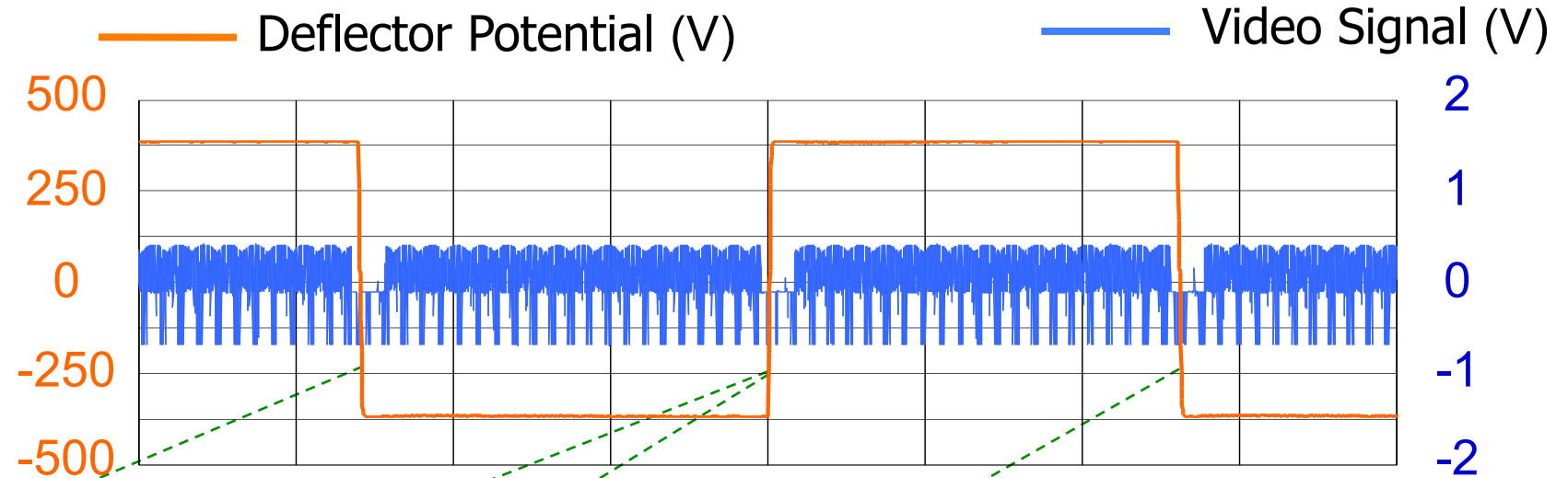
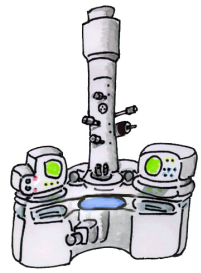

Odd Field (Left image)



Even Field (Right image)

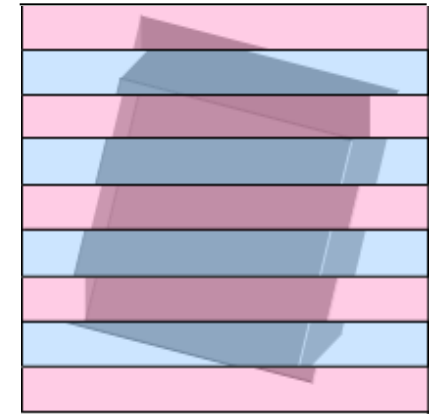

1Frame (Output image)

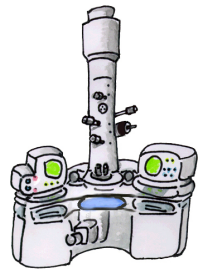

Illumination System

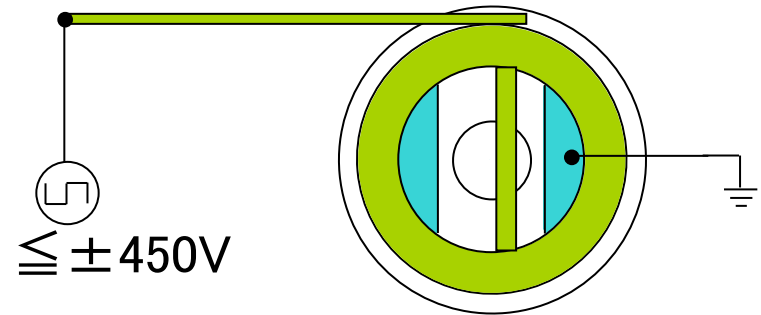
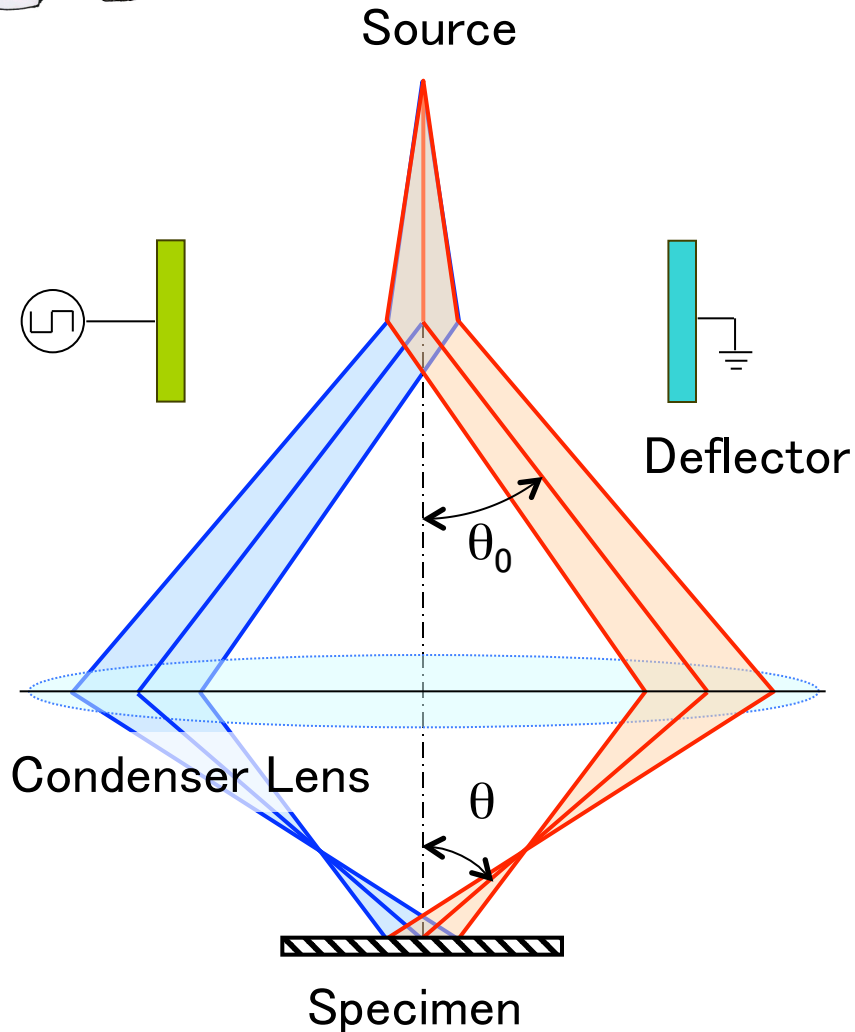

Max. Angle 0.081° (1.4mrad)

Required Angle: $\theta > 2^\circ$

Need Angle Mag.: $\times 25$

Image Mag.: $\times 1/25$



Use condenser lenses in a reduction mode.



$\pm 2.3^\circ$

Deflector and Specimen plane
should be conjugate.

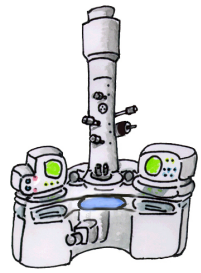

Stereo Pair of Au Particles

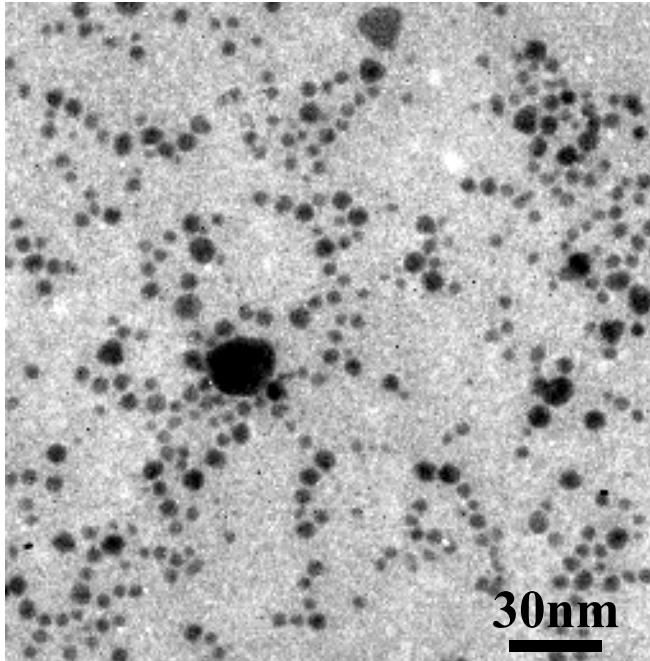

Right Image

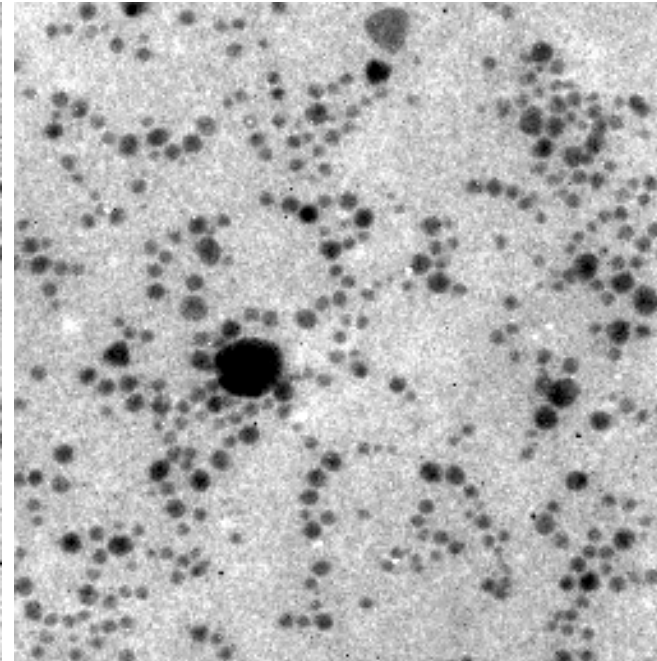

Left Image

Lateral Resolution: ~ 1 nm

Depth Resolution: ~ 13 nm

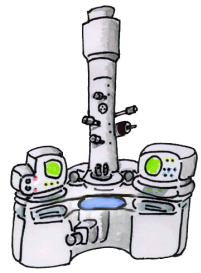

Real-Time Stereo Observation of ZnO

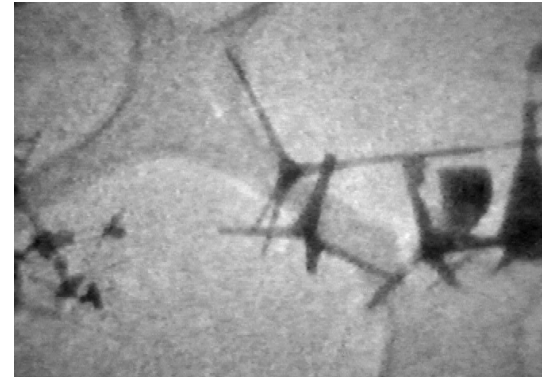
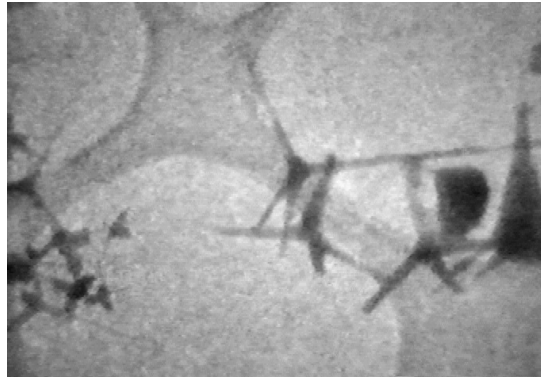

0.00 sec

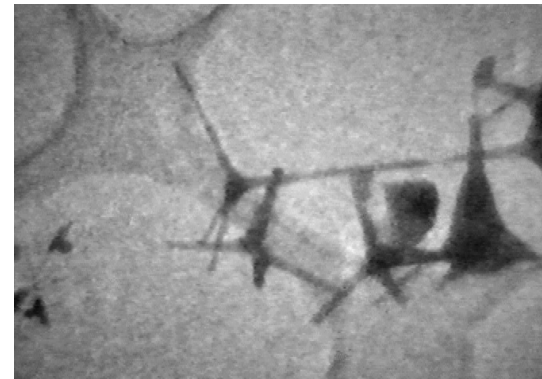
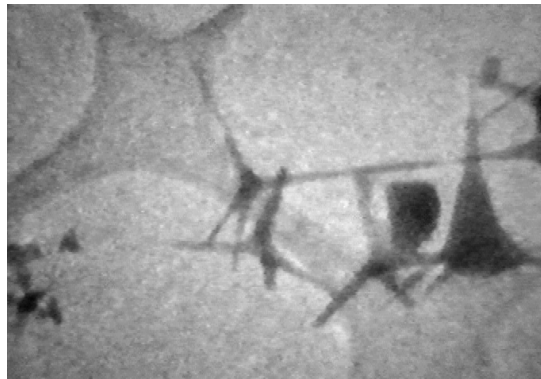

0.06 sec

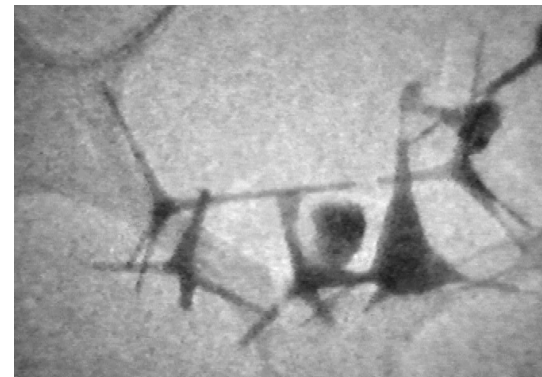
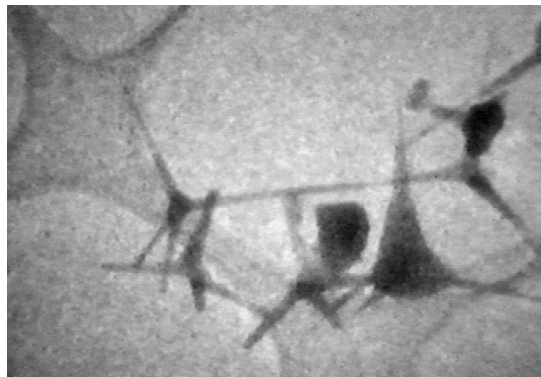

0.28 sec

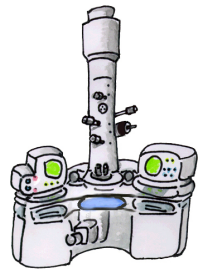

Real-Time Stereo TEM (HF-2000)

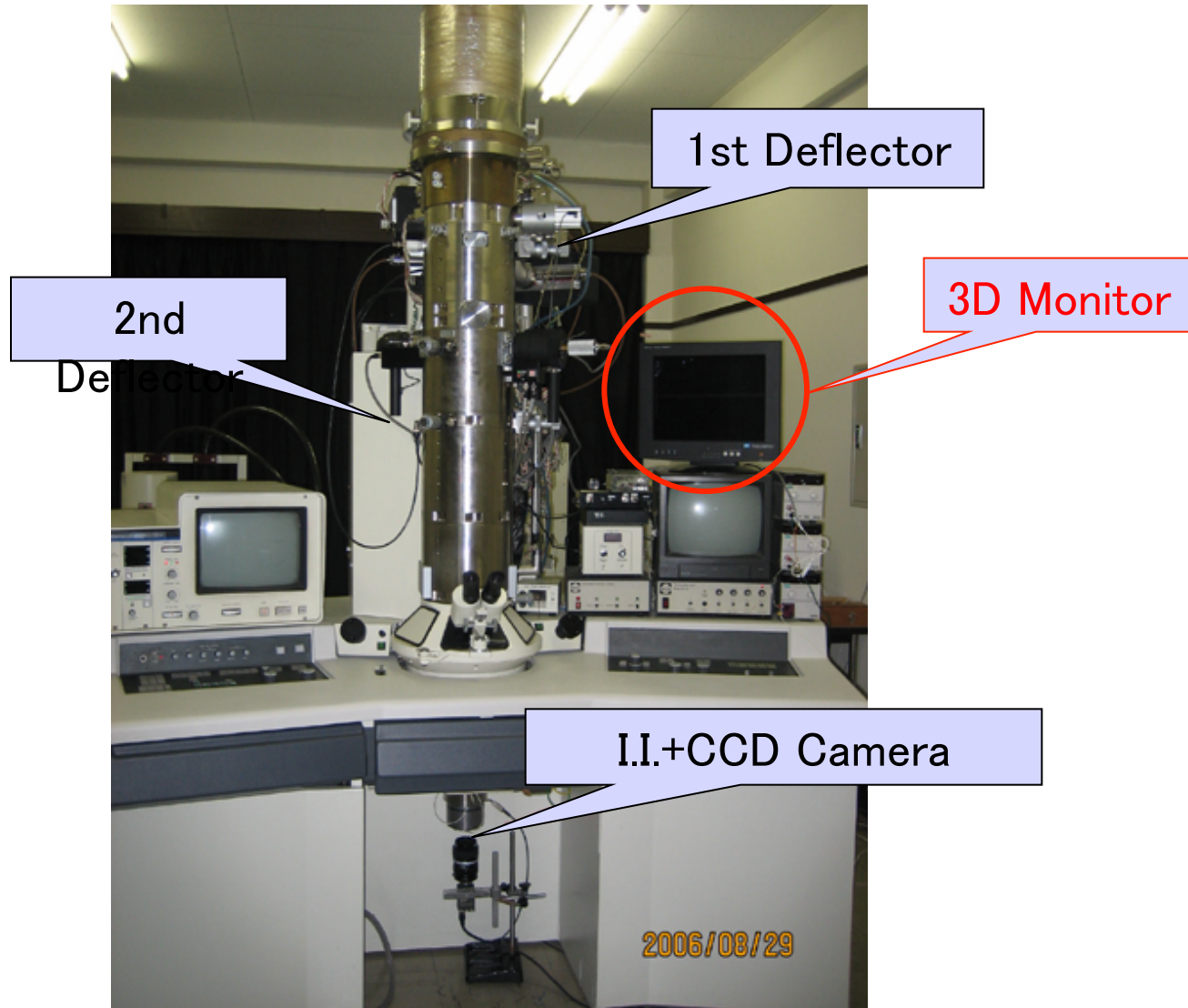

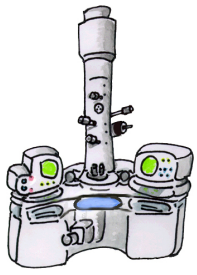

Depth Measurement

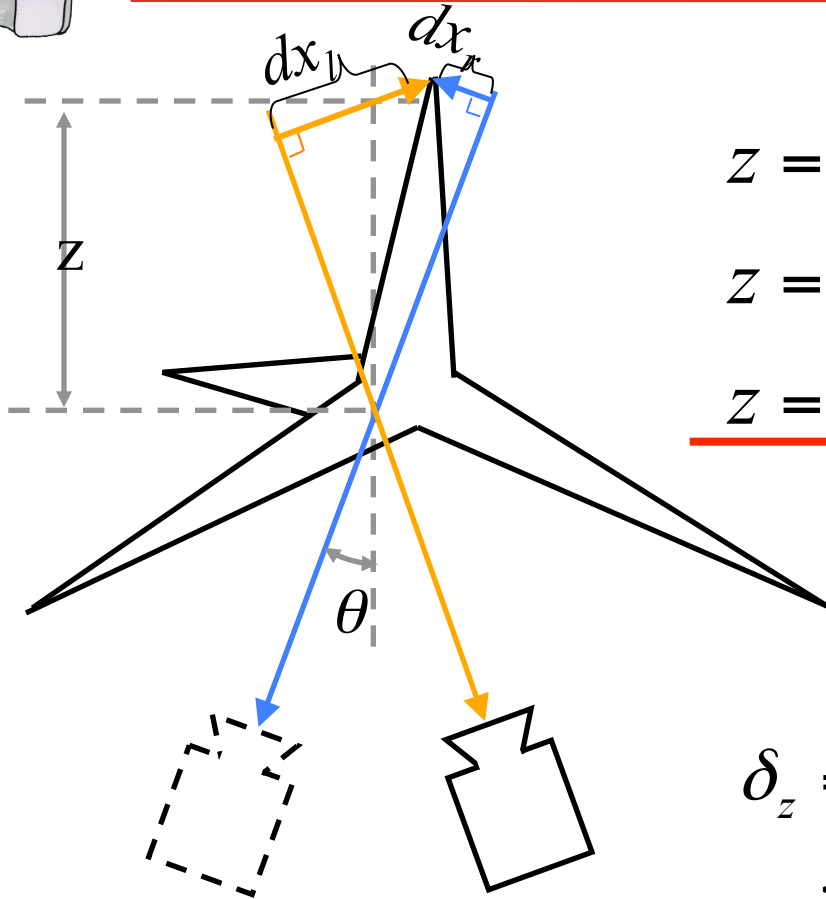

$$z = (dx_r / \sin \theta + dx_l / \sin \theta) / 2$$

$$z = (dx_r + dx_l) / 2 \sin \theta$$

$$\underline{z = dx / 2 \sin \theta}$$

$$\delta_z = \delta_x / 2 \sin 2.3^\circ$$

$$\leq 13 \text{ nm} \quad (\delta_x = 1 \text{ nm})$$

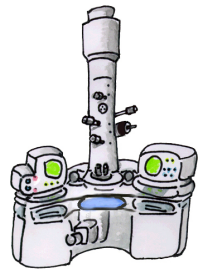

Detection of corresponding points

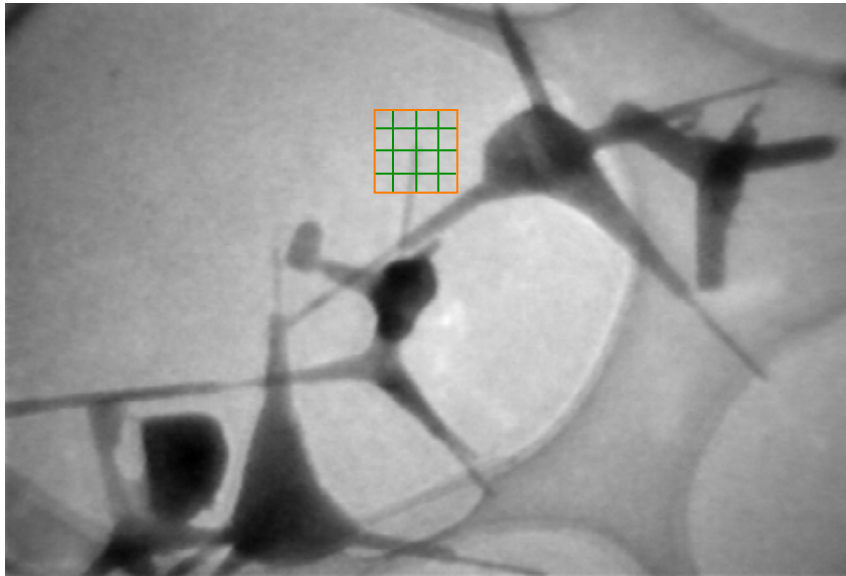

Right Image (standard)

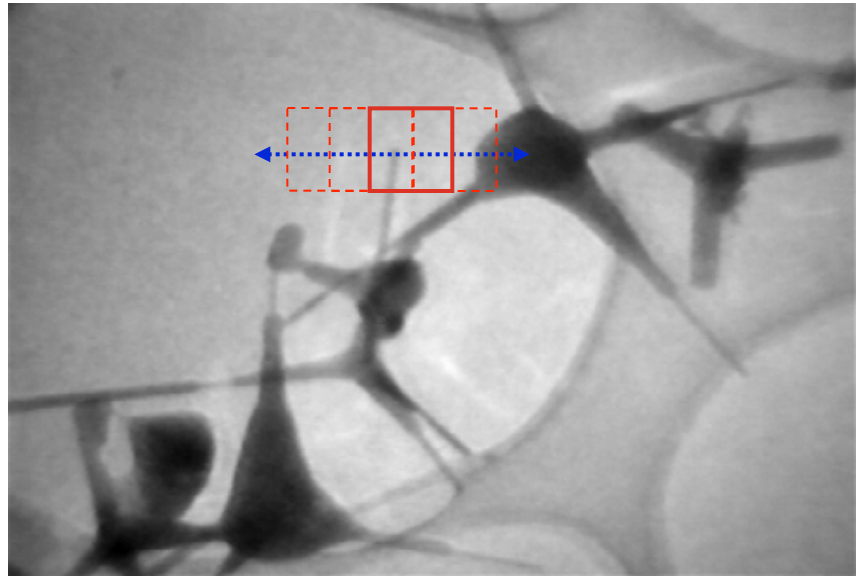

Left Image

Detection of corresponding points

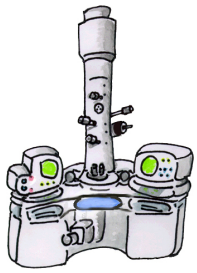

Outline extraction

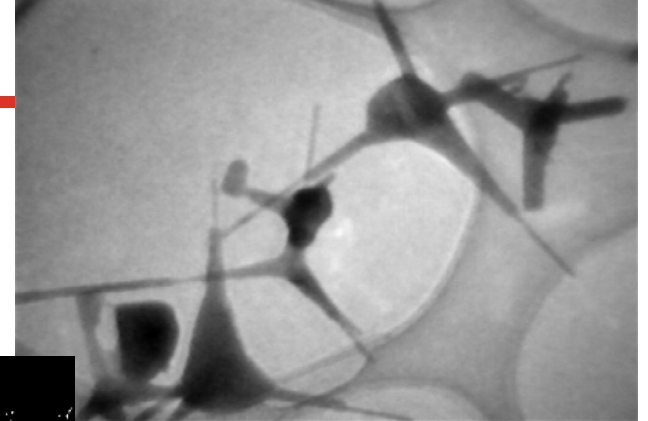

Standard Image

Characteristics



Thinning

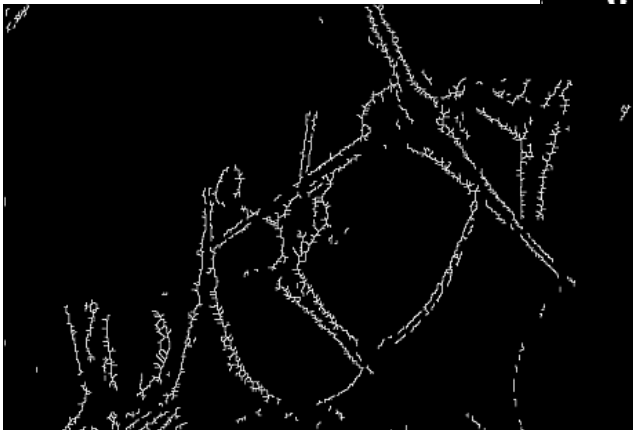

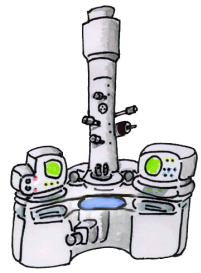

3-D Reconstruction and Plot

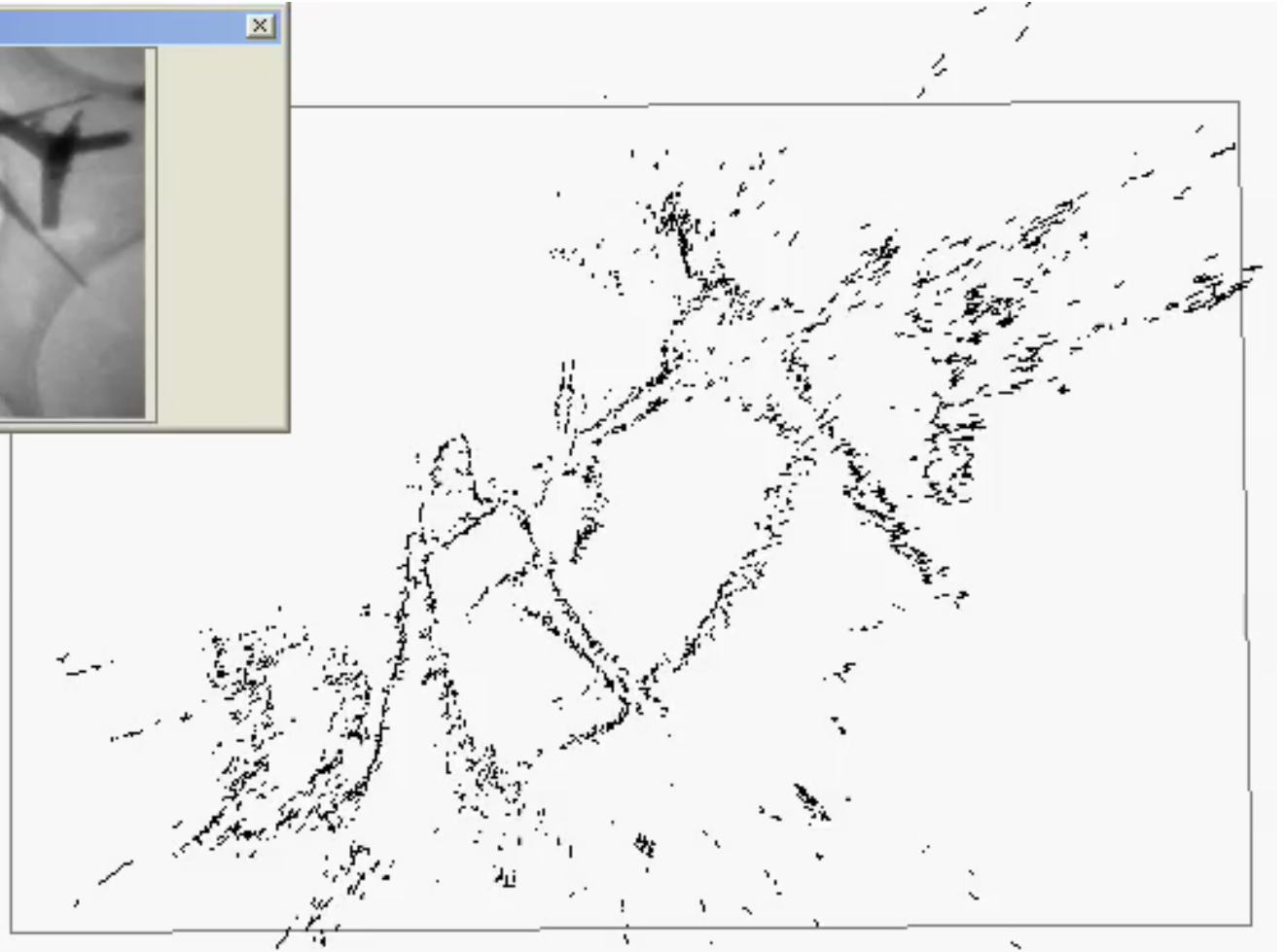
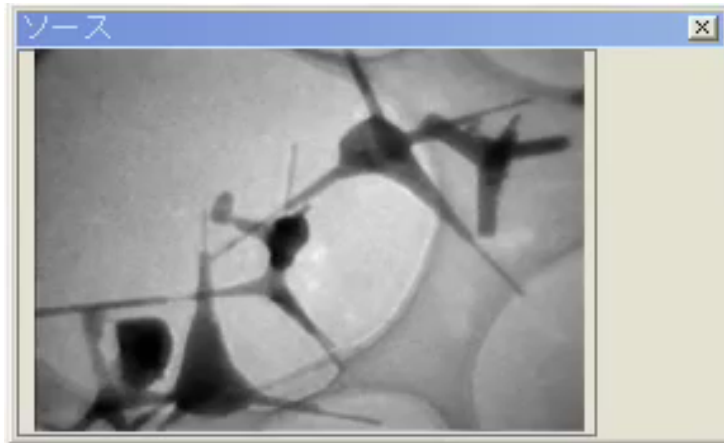

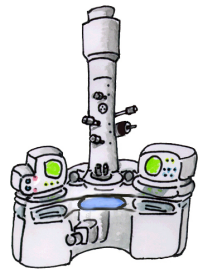

Continuous Observation by 3D Plot

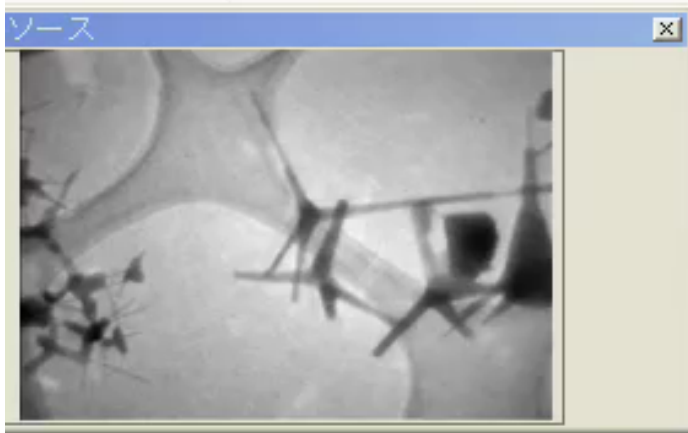

(Actual time)

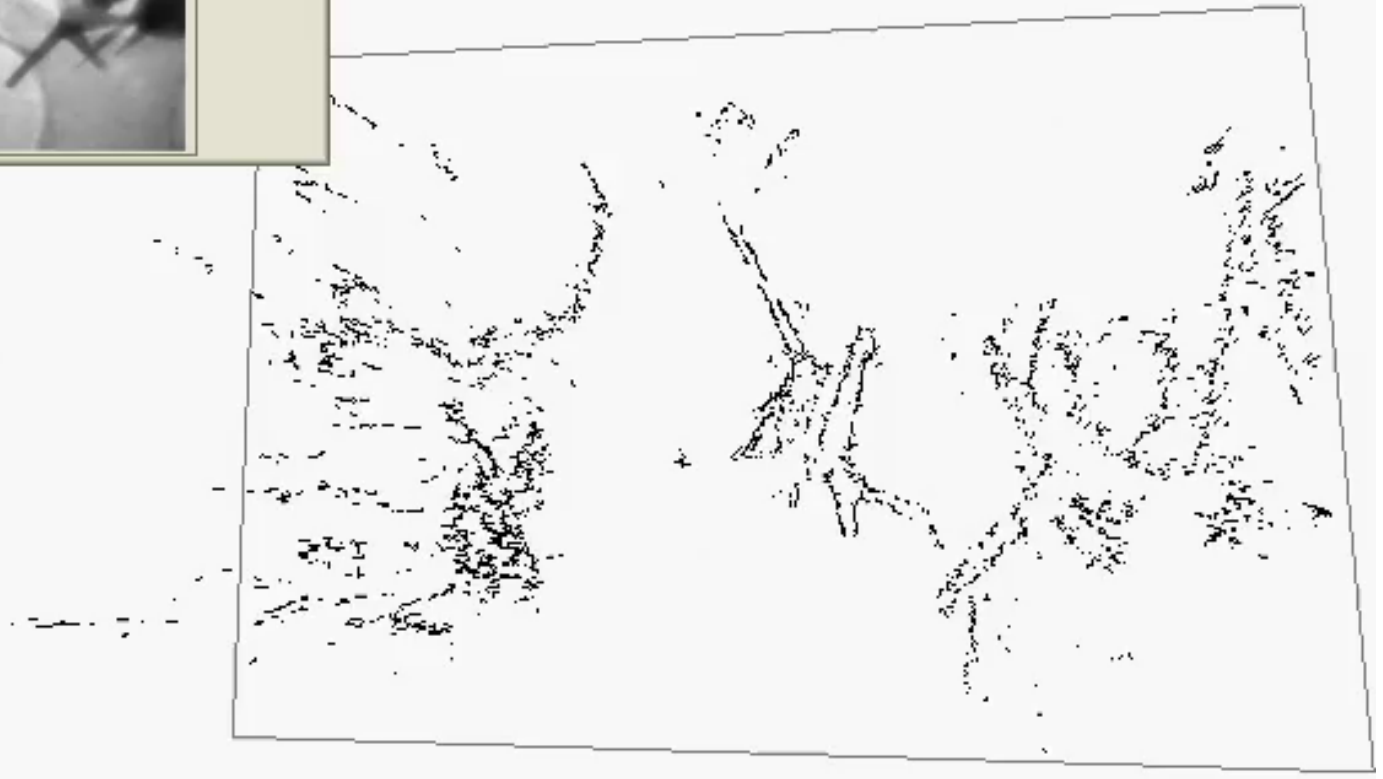

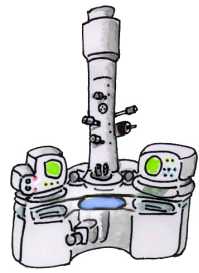

Summary of the Real-Time 3D-TEM

- Developed a real-time stereo TEM
 - Introduced electrostatic deflectors and a 3D-Monitor
 - Spatial resolution:

~ 1 nm	lateral
~13 nm	longitudinal
 - Temporal resolution

33 msec	(TV rate)
<5ms	expectable
- Developed an on-line 3D plot application
 - Extract characteristics and find corresponding points
 - Temporal resolution

2-8 sec	TV frame
---------	----------
 - Spatial resolution:

~18 px	longitudinal
	(estimation)

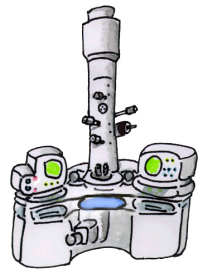

Contents

1. Introduction
2. Interference of waves
3. Electron holography
 - High resolution imaging
 - Observation of Magnetic field
5. Stereoscopic TEM
6. Phase plate using A-B effect

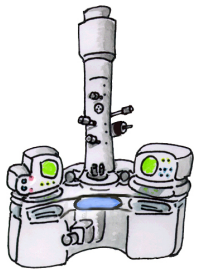

Hilbert Phase Plate for TEM

Thin film type Hilbert phase plate

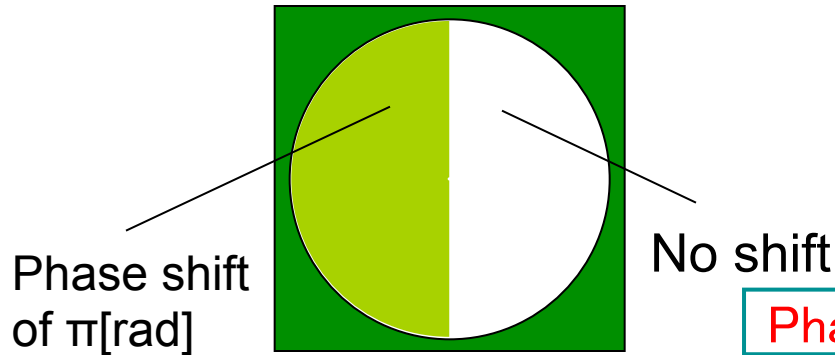

sgn function

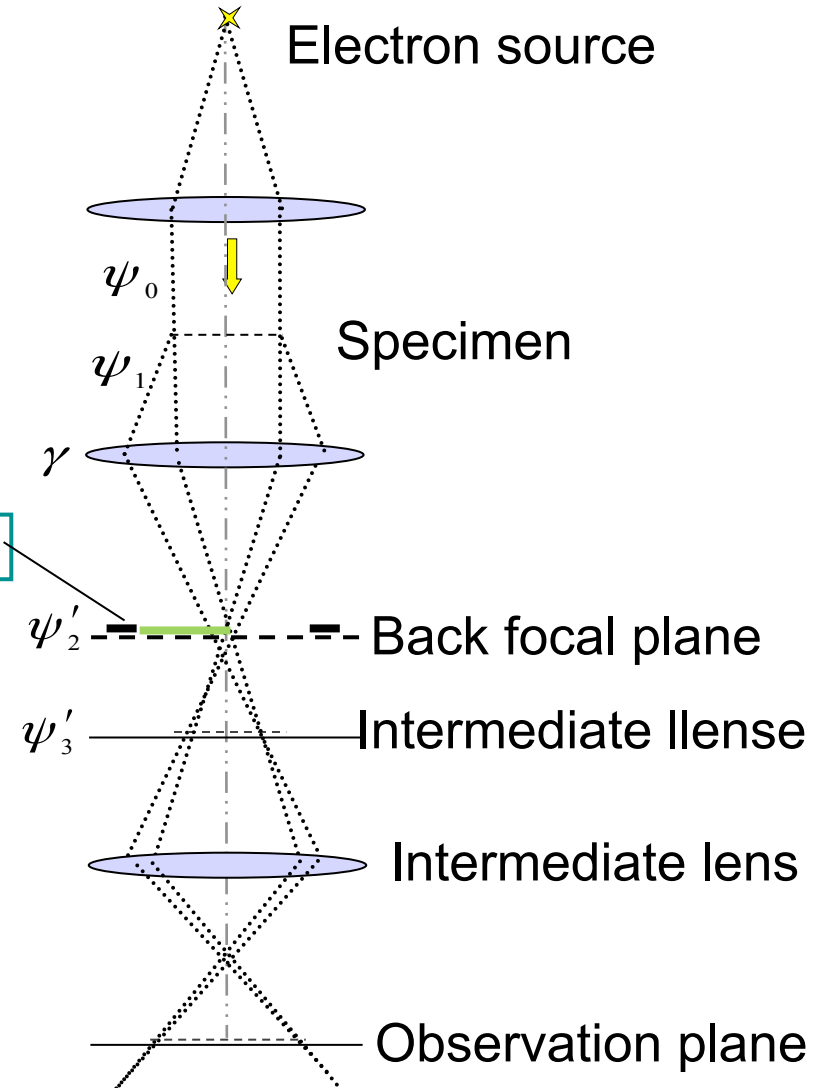
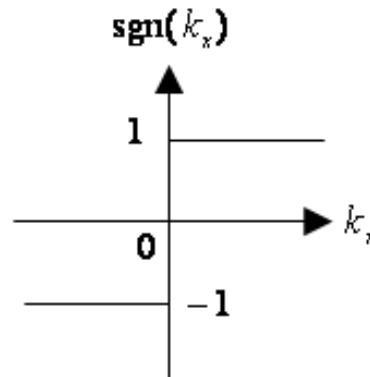

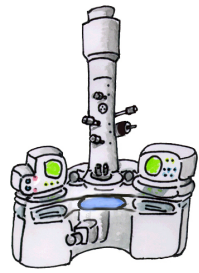

A-B Effect Phase Plate

Vector potential appearing with the magnetic flux inside the filament causes the phase shift of the electron wave pass through the both sides of the filament

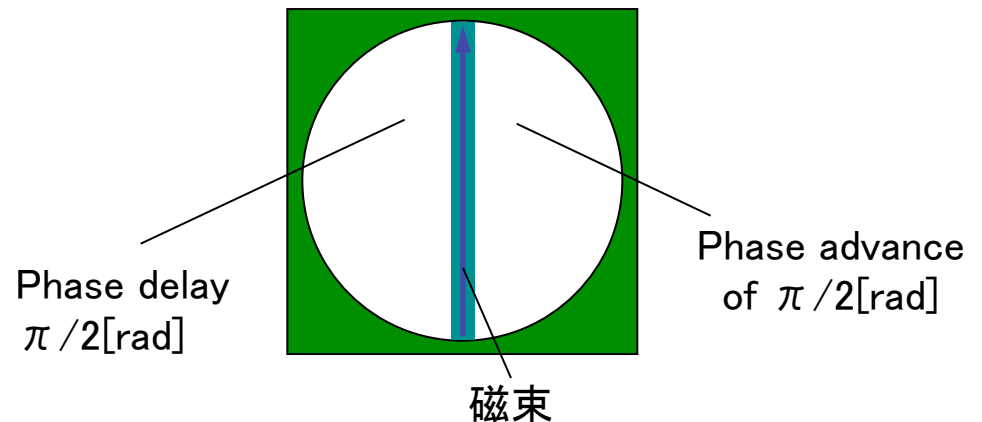
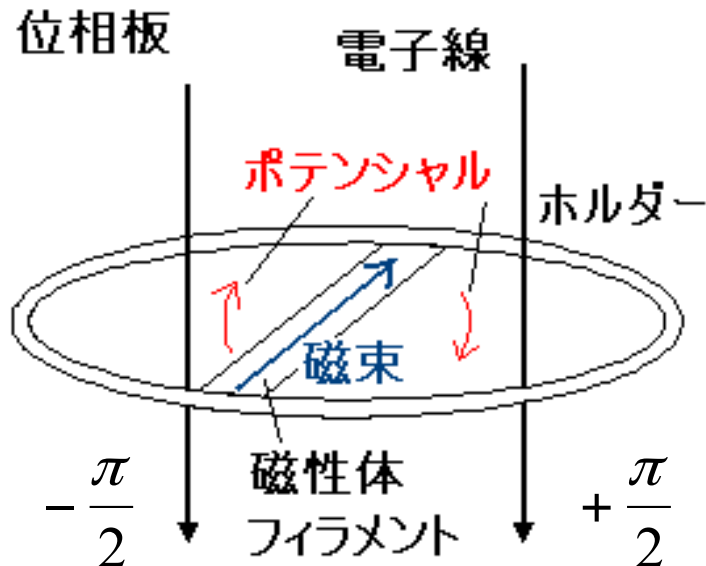

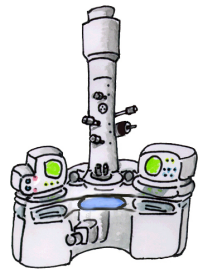

Phase Plate

Thin film type phase plate

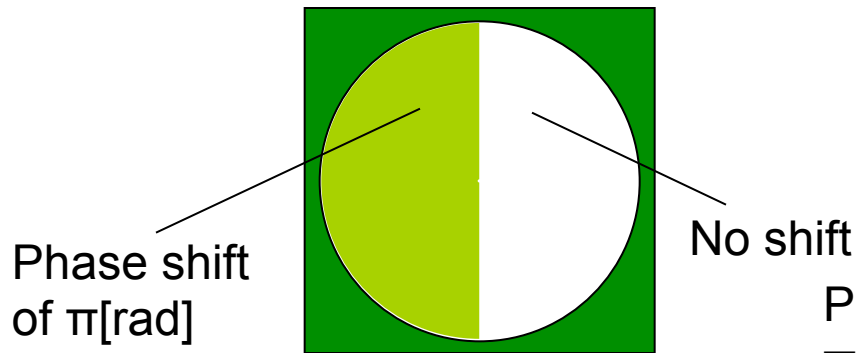

- Damage
- Short life time
- Degradation of image quality

A-B effect phase plate

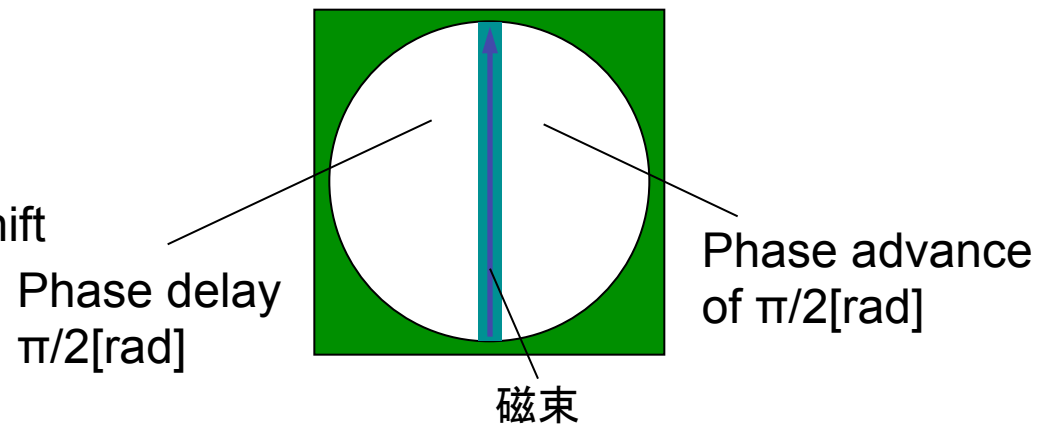

- Clean
- long life time
- Keeping image quality
- **Cannot centered**

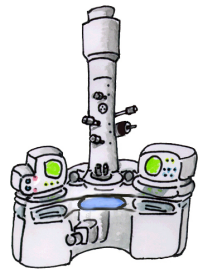

Phase Plate

Cross section of Wollaston wire

Phase plate

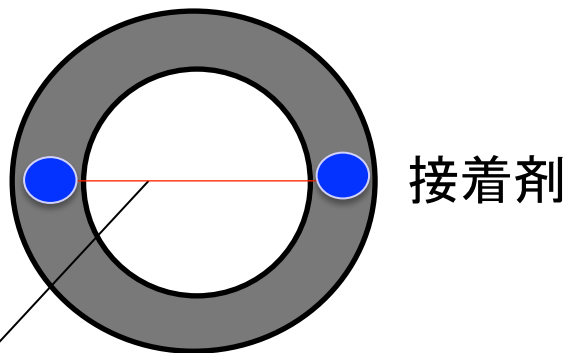

Single hole mesh

Magnetic filament

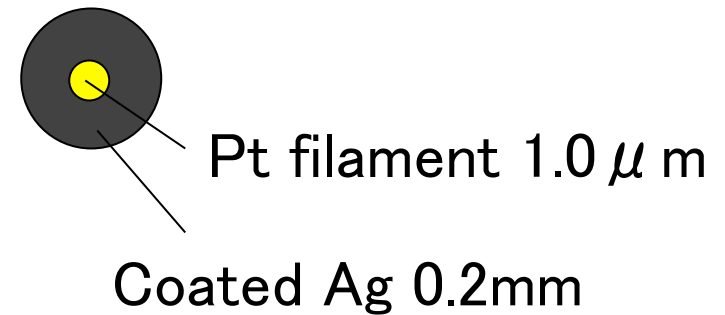

Filament

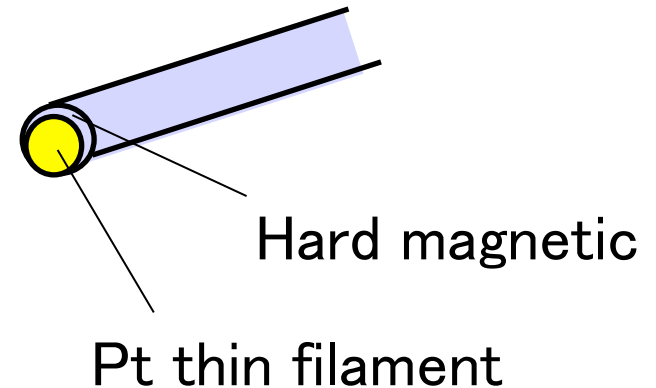

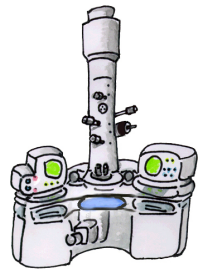

Phase Shift by A-B Effect

Reconstructed phase

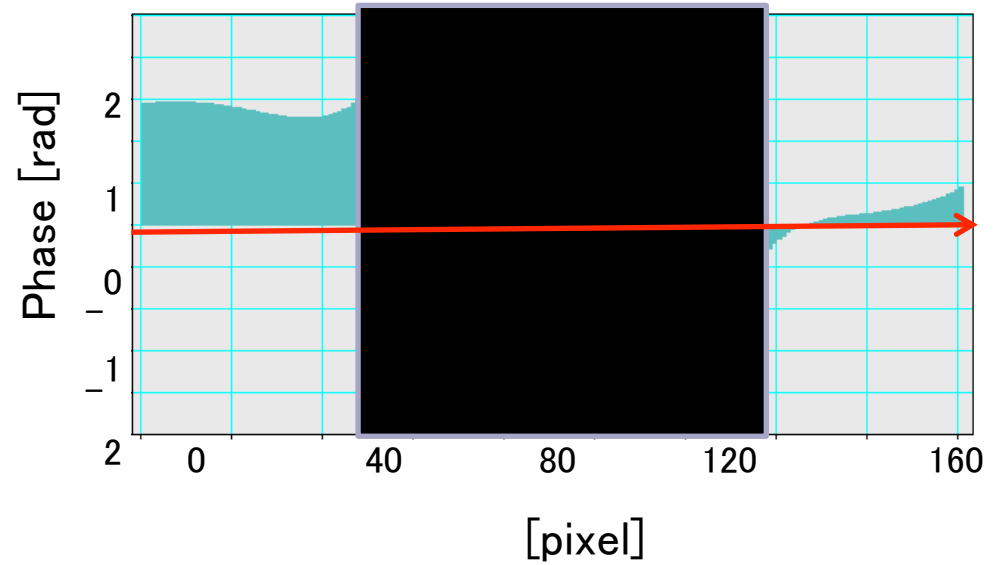
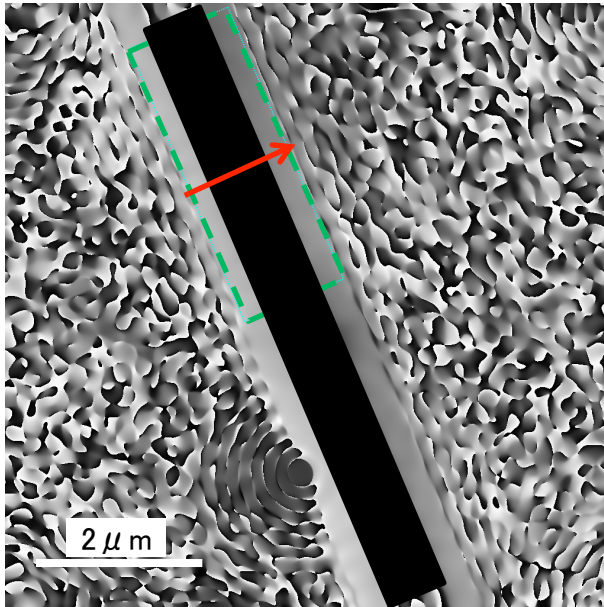

phase shift of $\sim 1.5\text{rad}$

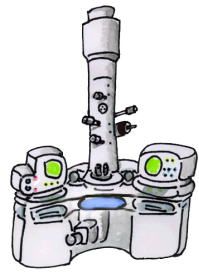

Differential Image of Holly C Film

Under-focus

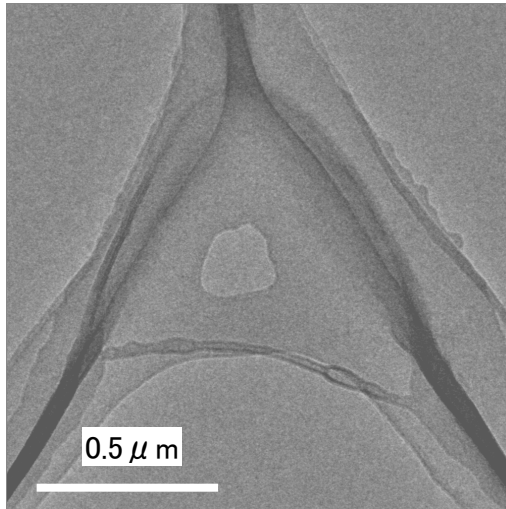

in-focus

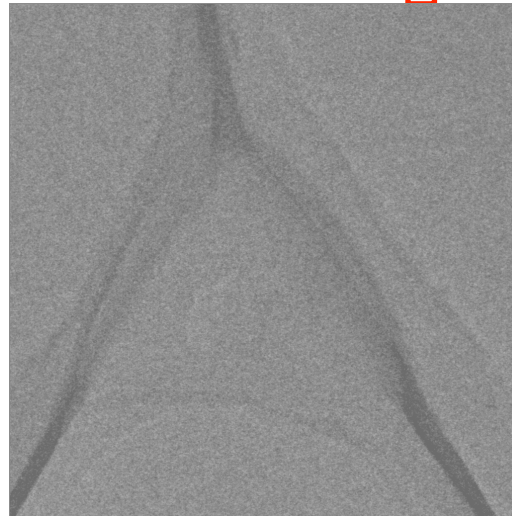

Insert filament

Differential image

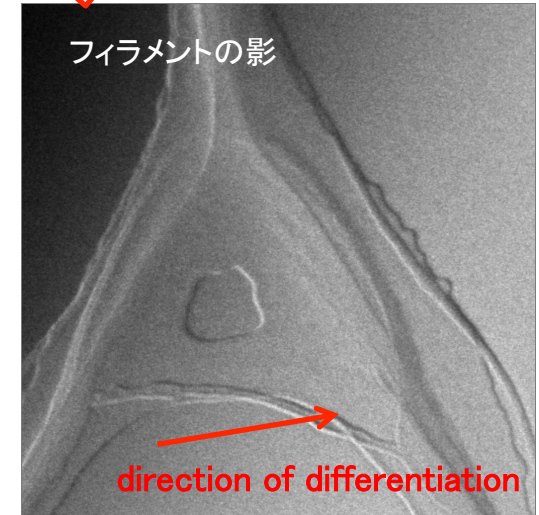

Obtain in-focus → Higher resolution

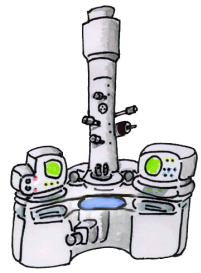

Differential Effect



under-focused

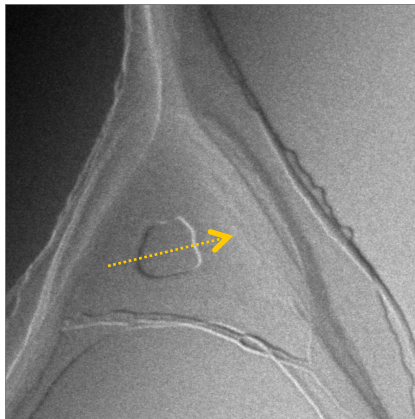

differential image

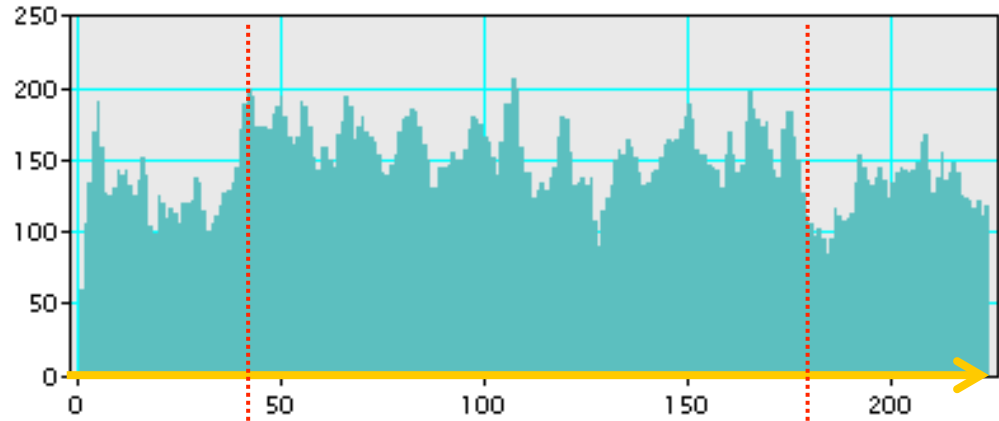

Line profile

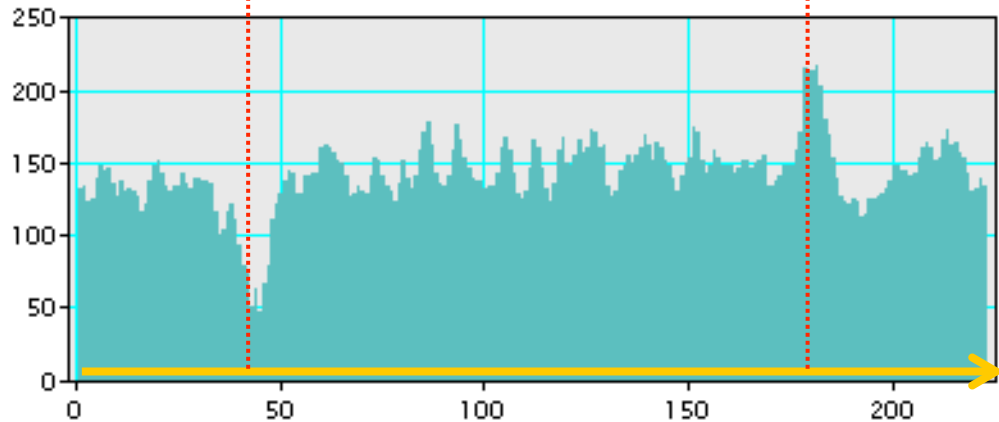

Line profile

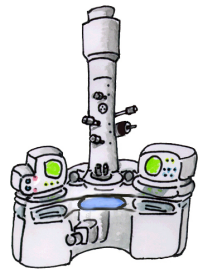

Observation of Bio-specimen

Colon bacillus (Pb stained)

Under-focused image

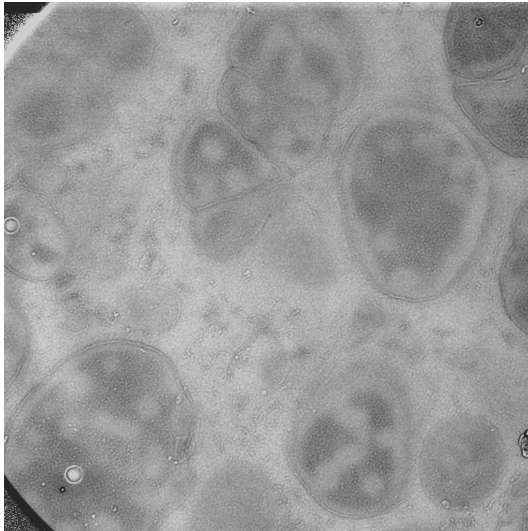

Differential image in focus

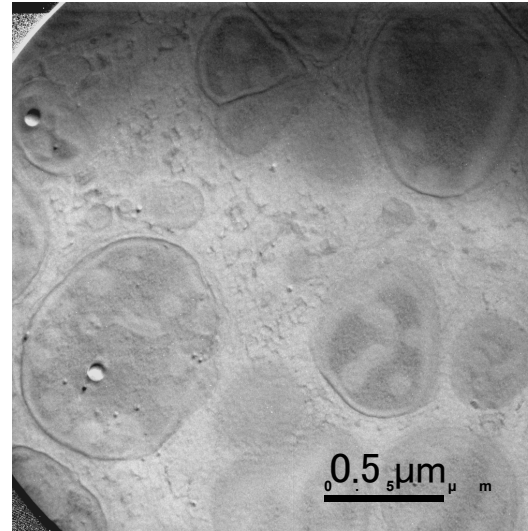

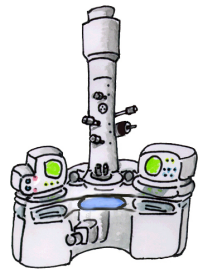

Observation of Bio-specimen

Colon bacillus (Pb stained)

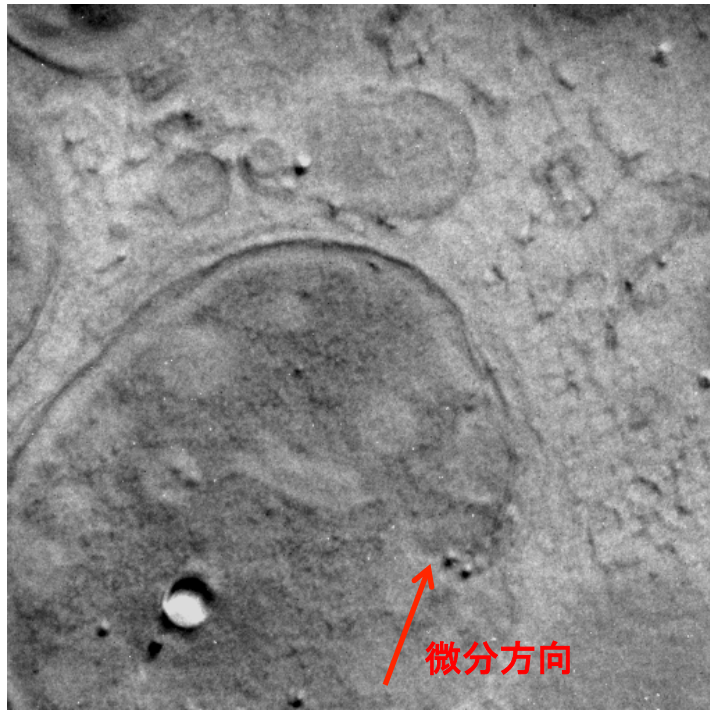

微分像

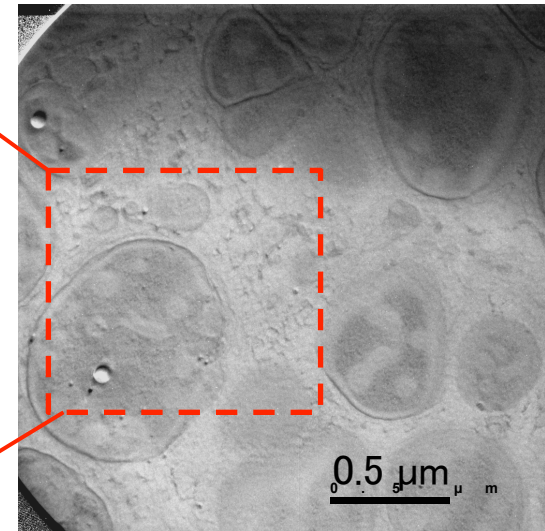

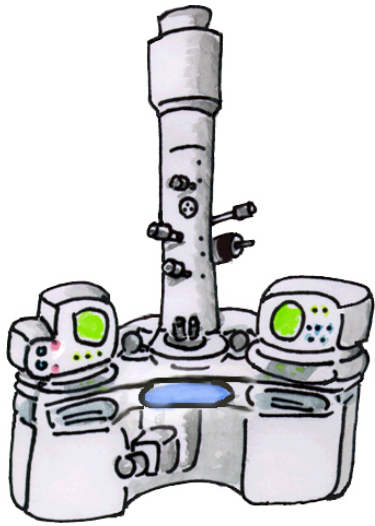

Thank you for your attention !!
